



quickmolding

obtenir un excellent
 finition finale et
 décoratif en très
 court temps.



quickmolding c'est un produit né pour résoudre facilement les détails de construction à la fois dans l'architecture moderne et dans l'architecture traditionnelle, en évitant certains problèmes qui étaient généralement créés lors de la construction avec l'utilisation de produits traditionnels.

Le matériau de base dont est fait le quickmolding est l'EPS (polystyrène expansé) et le XPS (polystyrène extrudé), un matériau à haute densité bien connu pour ses excellentes propriétés isolantes qui lui confèrent le volume requis avec un poids réduit.

quickmolding Il est livré avec une finition de surface en mortier élastomère si vous souhaitez avoir un comportement esthétique similaire à la pierre, au béton, à la peinture classique, etc.

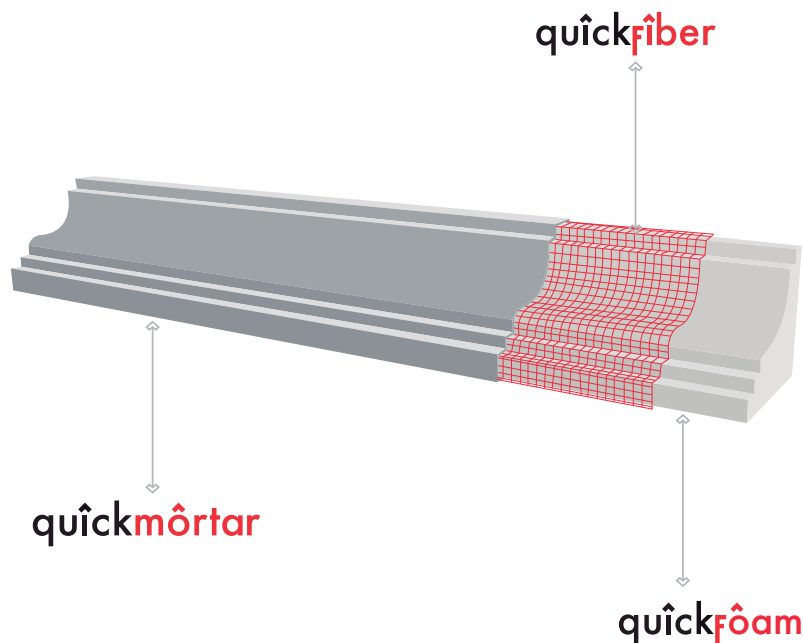

Avantage.

- ◇ Large gamme de modèles.
- ◇ Force face aux changements climatiques.
- ◇ Adaptation aux différents systèmes.
- ◇ Résistance et légèreté.
- ◇ Conceptions personnalisées.
- ◇ Affinité avec différentes finitions.
- ◇ Stabilité et faible coût.
- ◇ Installation facile.

España

+34868128999
+34619199399
+34606852013

Estados Unidos

+1 407 413 9329

Panamá

+507 833 7662

BANQUINAS

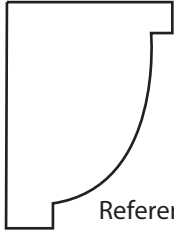

Referencia 001



Referencia 002



Referencia 003

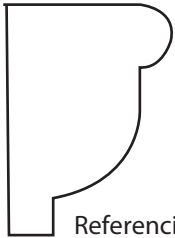

Referencia 004

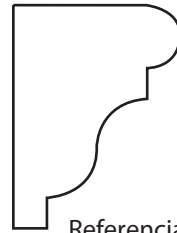

Referencia 005

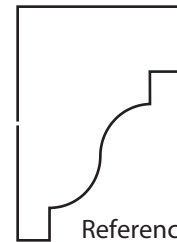

Referencia 006

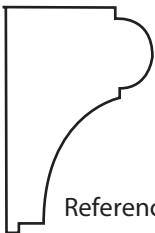

Referencia 007

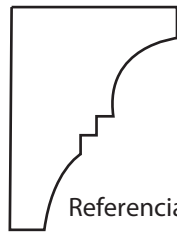

Referencia 008



Referencia 009

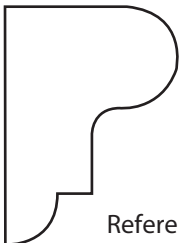

Referencia 010



Referencia 011



Referencia 012

España

+34868128999
+34619199399
+34606852013

Estados Unidos

+1 407 413 9329

Panamá

+507 833 7662



BORDS



Referencia 013



Referencia 014

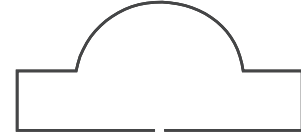

Referencia 015

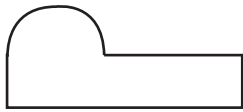

Referencia 016

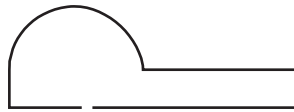

Referencia 017

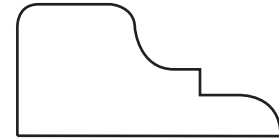

Referencia 018

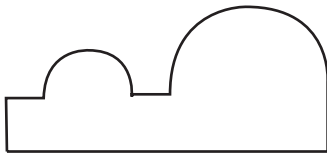

Referencia 019



Referencia 020



Referencia 021

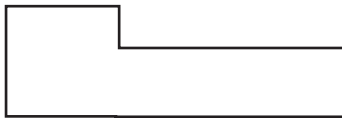

Referencia 022



Referencia 023

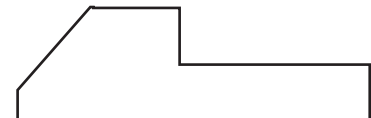

Referencia 024

España

+34868128999
+34619199399
+34606852013

Estados Unidos













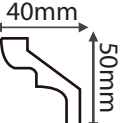

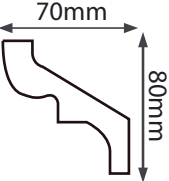

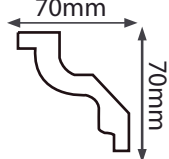
+1 407 413 9329

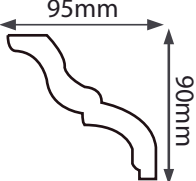
Panamá

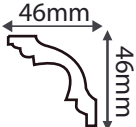
+507 833 7662

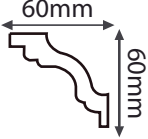

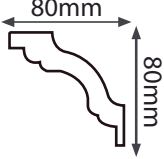
CORNISAS

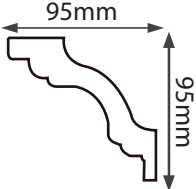
	Referencia 025	
	Referencia 026	
	Referencia 027	
	Referencia 028	
	Referencia 029	
	Referencia 030	
	Referencia 031	
	Referencia 032	
	Referencia 033	

España

+34868128999
+34619199399
+34606852013

Estados Unidos

+1 407 413 9329

Panamá

+507 833 7662



CORNISAS

	Referencia 034	
	Referencia 035	
	Referencia 036	
	Referencia 037	
	Referencia 038	
	Referencia 039	
	Referencia 040	
	Referencia 041	
	Referencia 042	

España

+34868128999
+34619199399
+34606852013

Estados Unidos

+1 407 413 9329

Panamá

+507 833 7662



Cornisas



Referencia 043

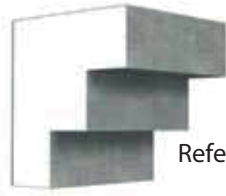

Referencia 049



Referencia 044



Referencia 050



Referencia 045



Referencia 051



Referencia 046

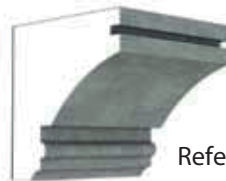

Referencia 052



Referencia 047



Referencia 053



Referencia 048



Referencia 054

Corbeaux



Referencia 050



Referencia 051



Referencia 052

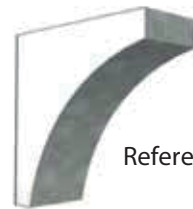

Referencia 053



Referencia 054



Referencia 055

España

+34868128999
+34619199399
+34606852013

Estados Unidos

+1 407 413 9329

Panamá

+507 833 7662

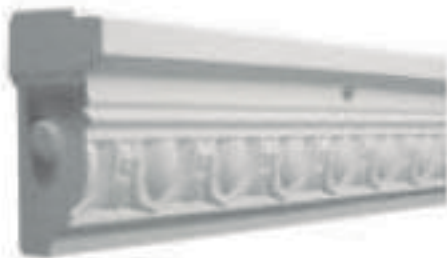

Referencia 056



Referencia 060

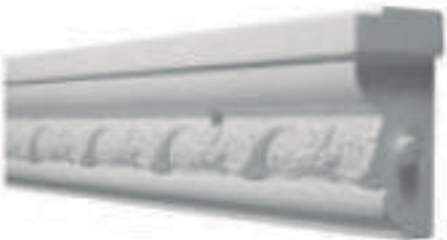

Referencia 057



Referencia 061



Referencia 058



Referencia 062



Referencia 059



Referencia 063

España

+34868128999
+34619199399
+34606852013

Estados Unidos

+1 407 413 9329

Panamá

+507 833 7662



Referencia 064



Referencia 065



Referencia 066



Referencia 067



Referencia 068



Referencia 069



Referencia 070



Referencia 071



Referencia 072



Referencia 073



Referencia 074

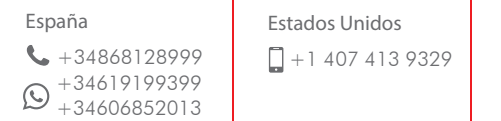

Referencia 075



Referencia 076



Referencia 077



Referencia 078



Referencia 079



Referencia 080



Referencia 081



Referencia 082



Referencia 083



Referencia 084



Referencia 085



Referencia 086



Referencia 087



Referencia 088



Referencia 089

Referencia 090

Referencia 091

Referencia 092

Referencia 093

España

+34868128999
+34619199399
+34606852013

Estados Unidos

+1 407 413 9329

Panamá

+507 833 7662

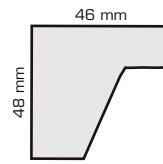

Referencia 094

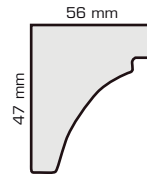

Referencia 095

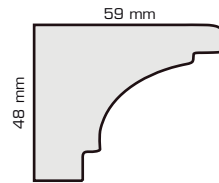

Referencia 096

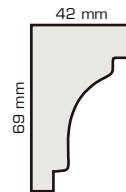

Referencia 097

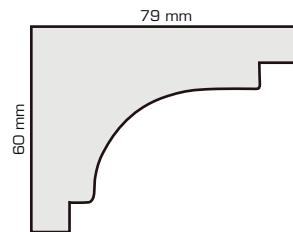
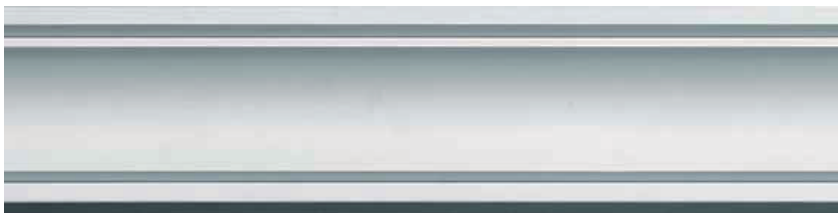

Referencia 098

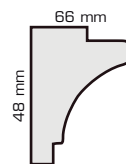

Referencia 099

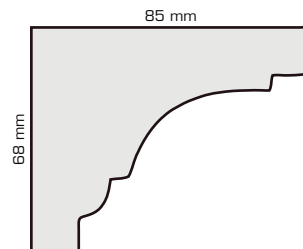

Referencia 100

España









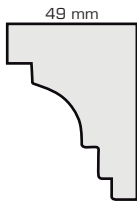
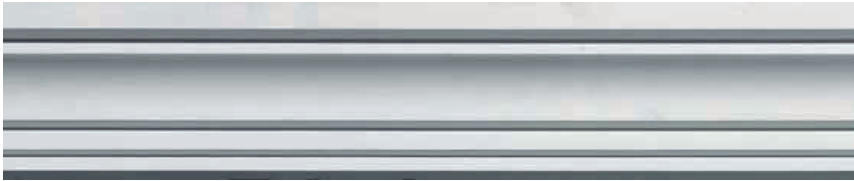
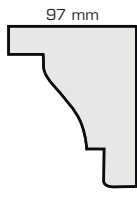

+34868128999
+34619199399
+34606852013

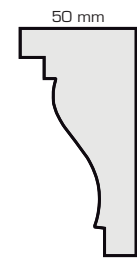
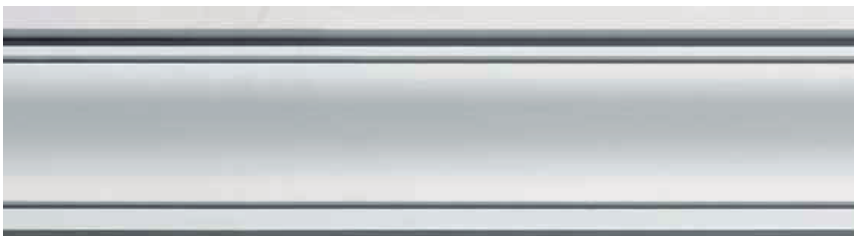
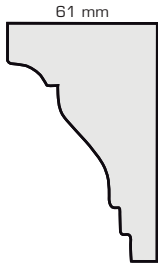
Estados Unidos

+1 407 413 9329

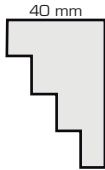
Panamá

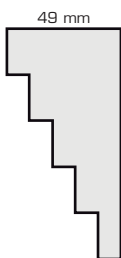
+507 833 7662

Referencia 101	 <p>49 mm</p>	
Referencia 102	 <p>97 mm</p>	
Referencia 103	 <p>50 mm</p>	
Referencia 104	 <p>61 mm</p>	
Referencia 105	 <p>30 mm</p>	
Referencia 106	 <p>40 mm</p>	
Referencia 107	 <p>49 mm</p>	



COLUMNAS



Ref.: 108
Pieza columna
estriada
168 cm
Ø 13 cm



Ref.: 109
Pieza columna
estriada
110 cm
Ø 18 cm



Ref.: 110
Pieza columna
estriada
193 cm
Ø 18 cm



Ref.: 111
Pieza columna
estriada
177 cm
Ø 20 cm



Ref.: 112
Pieza columna
conica
159 cm
Ø 15 cm

España

+34868128999
+34619199399
+34606852013

Estados Unidos

+1 407 413 9329

Panamá

+507 833 7662

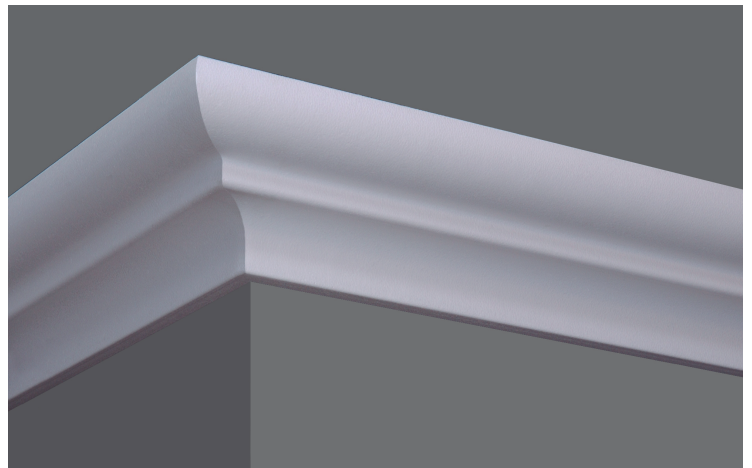
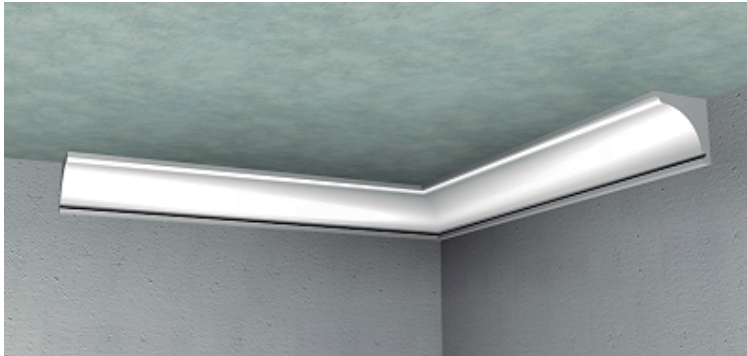
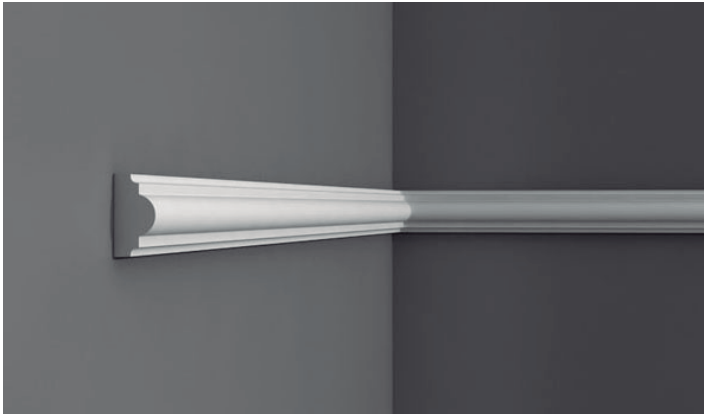

España

+34868128999
+34619199399
+34606852013

Estados Unidos

+1 407 413 9329

Panamá

+507 833 7662

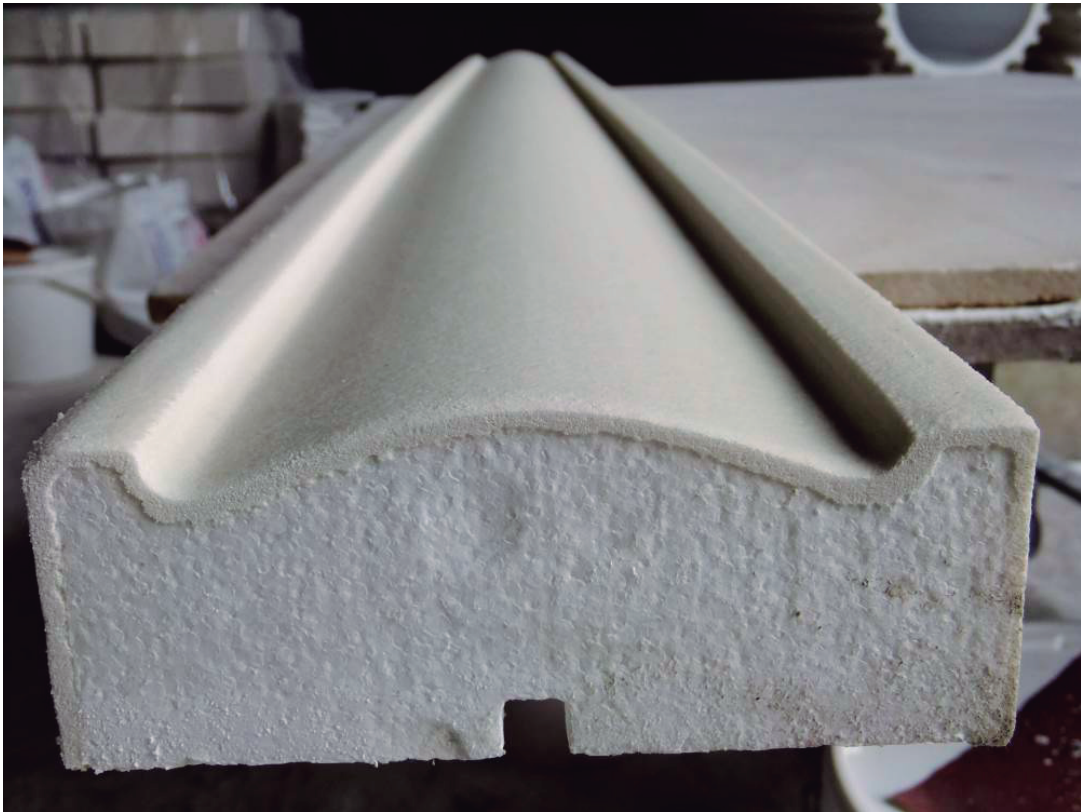

España

+34868128999
+34619199399
+34606852013

Estados Unidos

+1 407 413 9329

Panamá

+507 833 7662

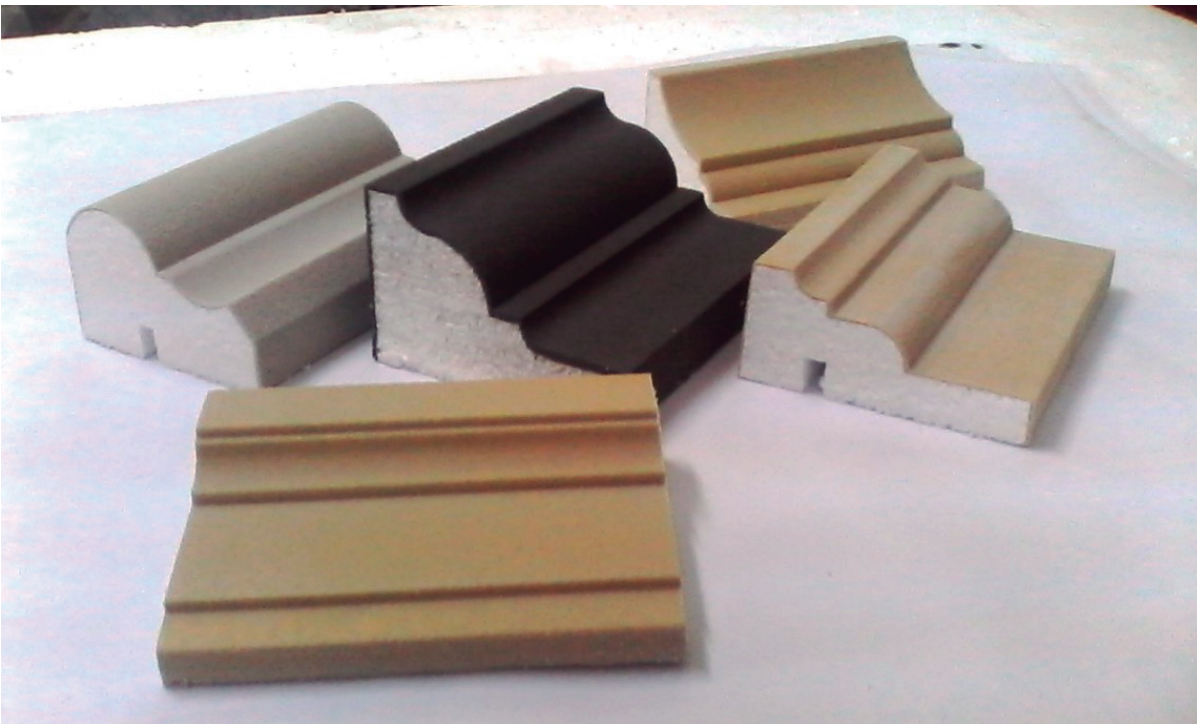

España

+34868128999
+34619199399
+34606852013

Estados Unidos

+1 407 413 9329

Panamá

+507 833 7662

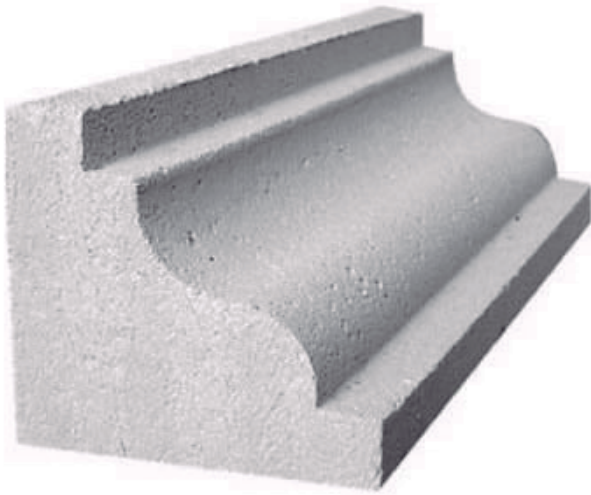
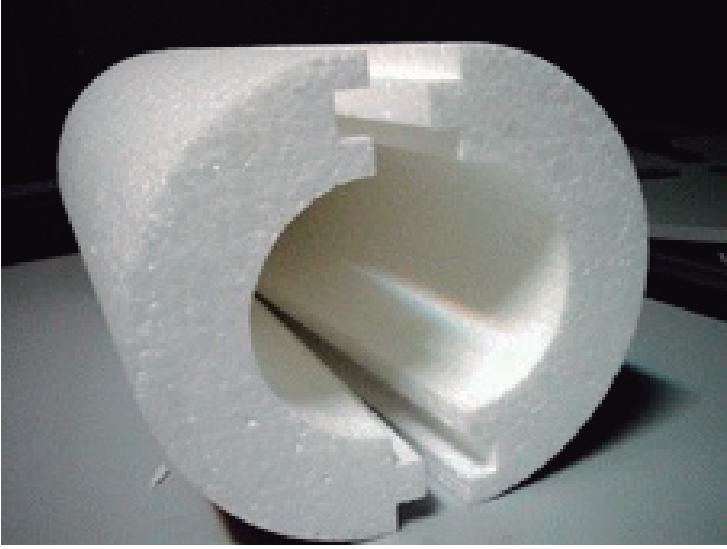

España

+34868128999
+34619199399
+34606852013

Estados Unidos

+1 407 413 9329

Panamá

+507 833 7662

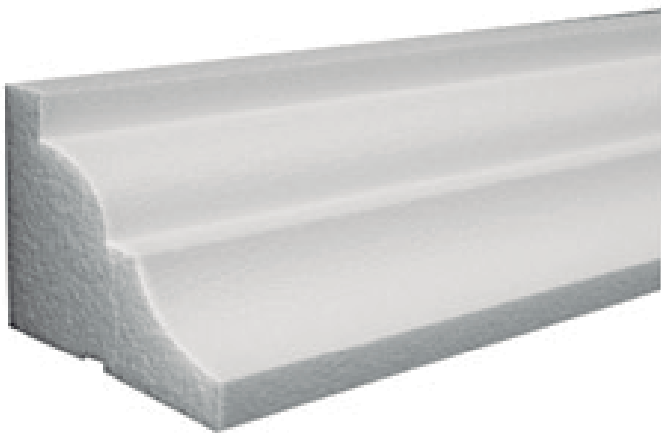
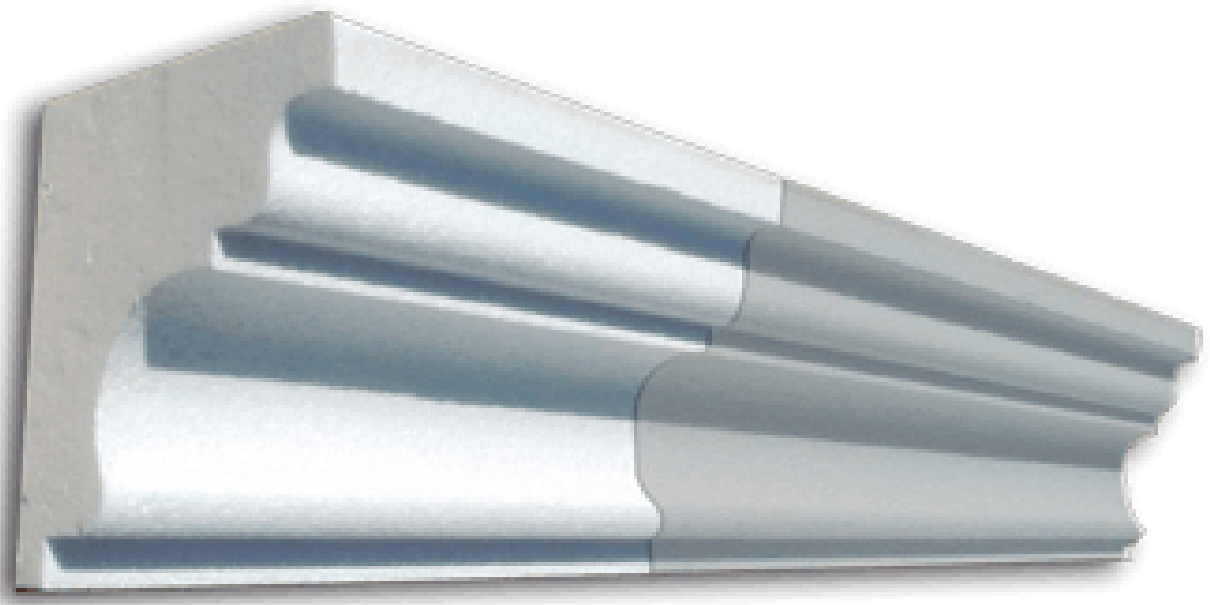

España

+34868128999
+34619199399
+34606852013

Estados Unidos

+1 407 413 9329

Panamá

+507 833 7662

FACILITÉ

quickmolding Ils peuvent être installés sur tout type de mur, en utilisant le adhésif adapté.

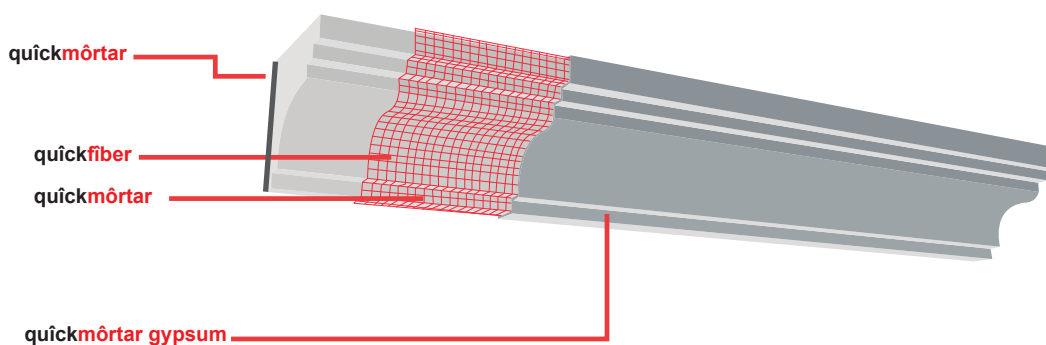

INSTRUCTIONS

- Vérifiez que le mur où la garniture est placée est d'aplomb.
- Marquez le niveau où la garniture sera installée.
- Préparer l'adhésif quickmôrtar
- Lieu quickmôrtar dans le mur et dans la moulure
- Installer la garniture
- Garniture de détail
- Donner la finition.



España

+34868128999
+34619199399
+34606852013

Estados Unidos

+1 407 413 9329

Panamá

+507 833 7662

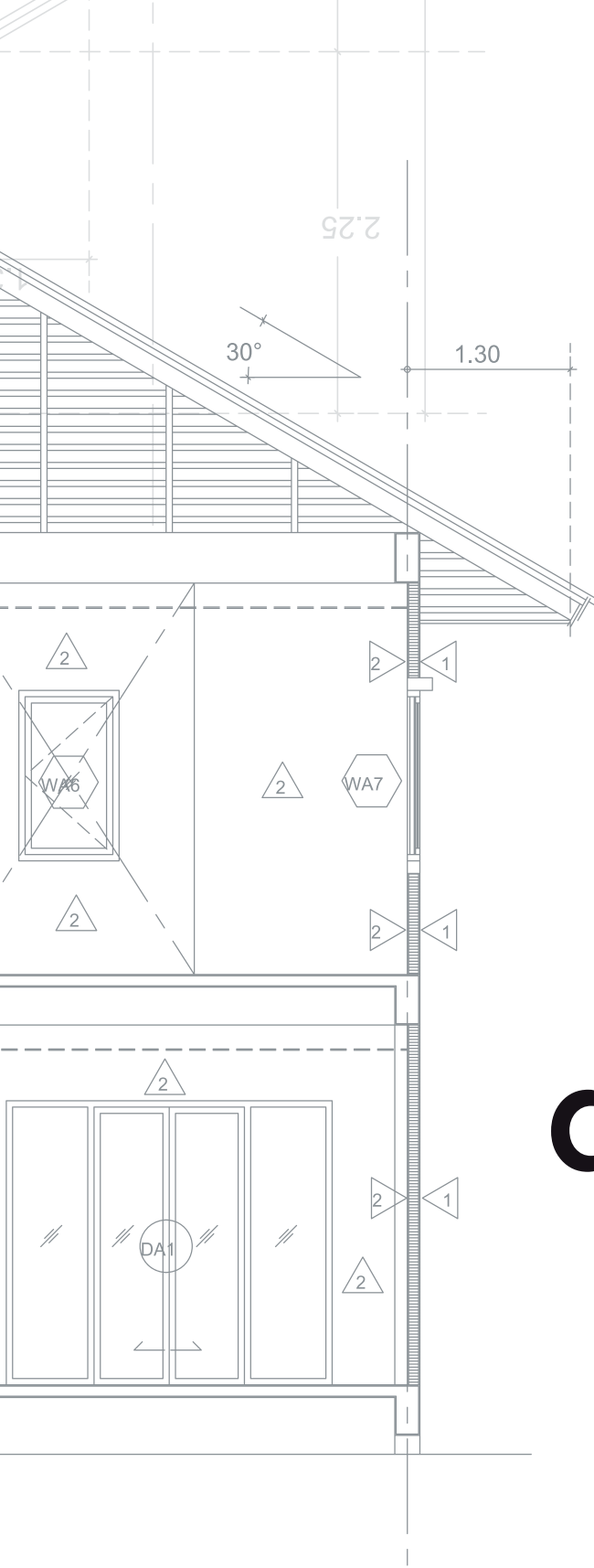

quïckplâck®

España

+34868128999

+34619199399

+34606852013

Panamá

+507 833 7662

Estados Unidos

+1 407 413 9329

quickplack@quickplack.com

www.quickplack.com