

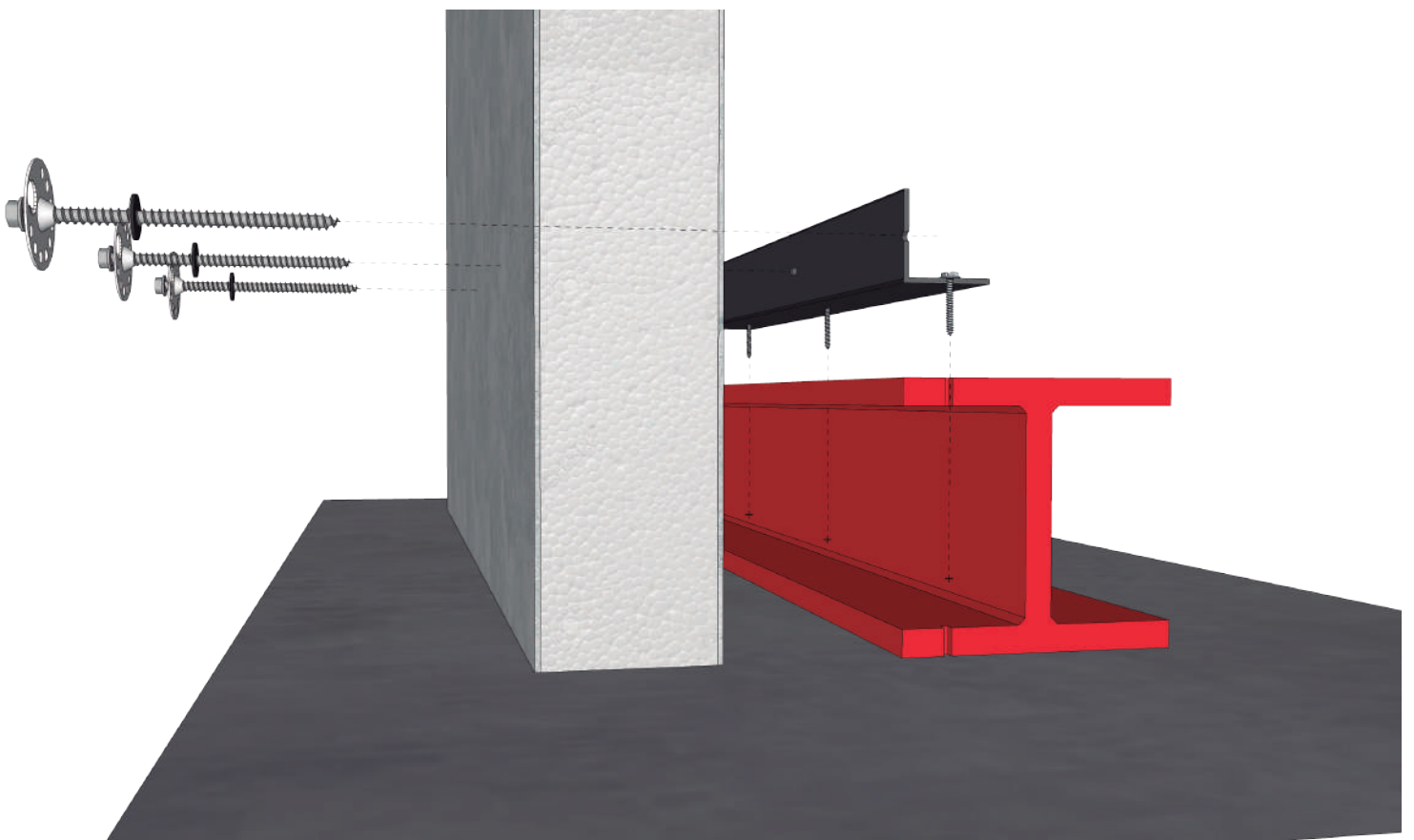

quïckplâck®

Manuel des installations et solutions quïckplâck



DÉTAIL DES JOINTS DE SURFACE ENTRE PANNEAUX

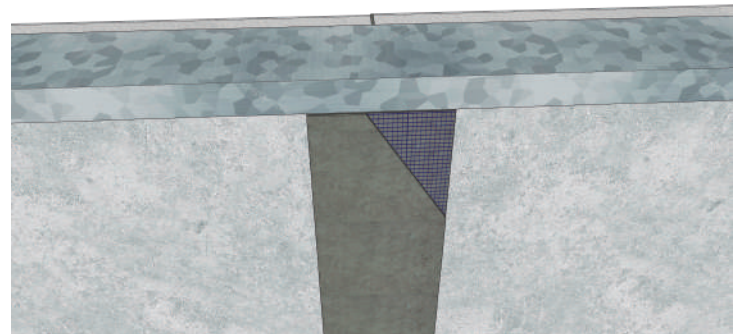
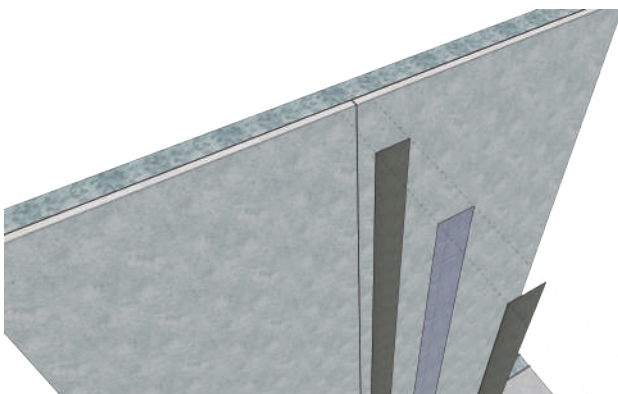
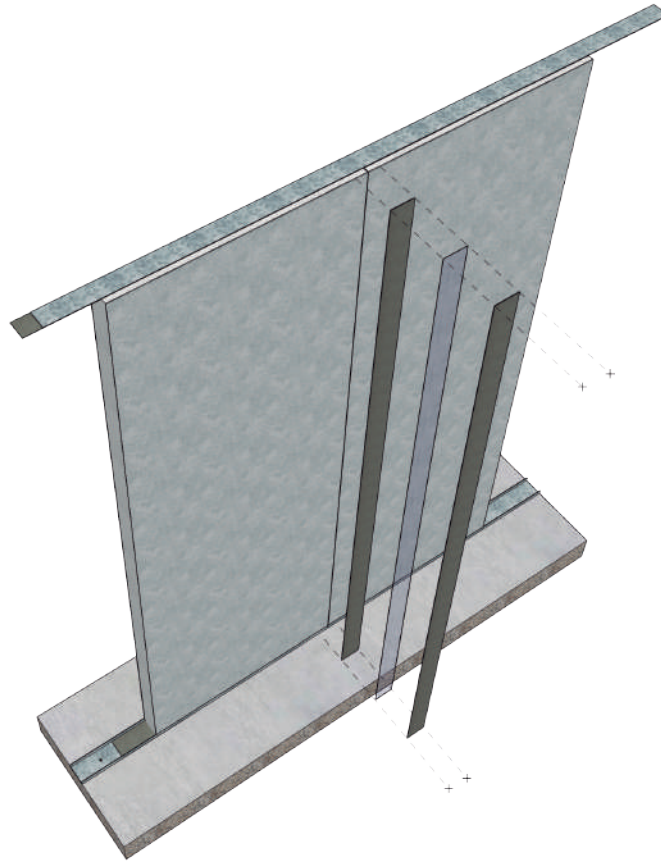

DÉTAIL DE LA RÉUNION DU PANEL - VAN

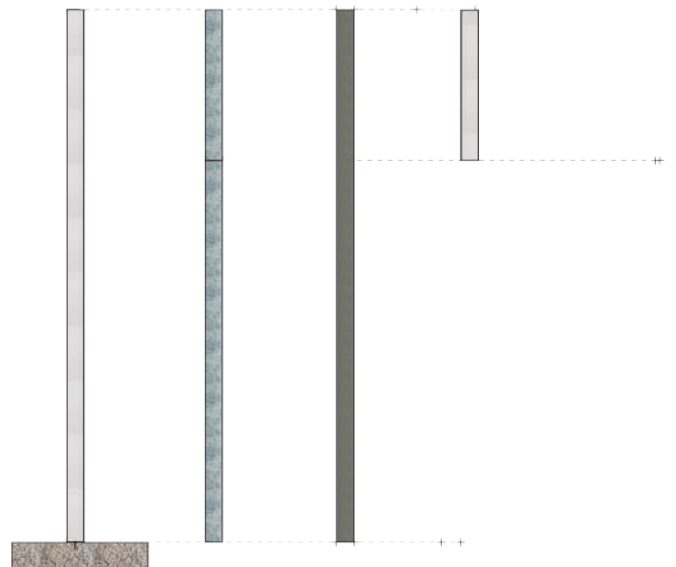
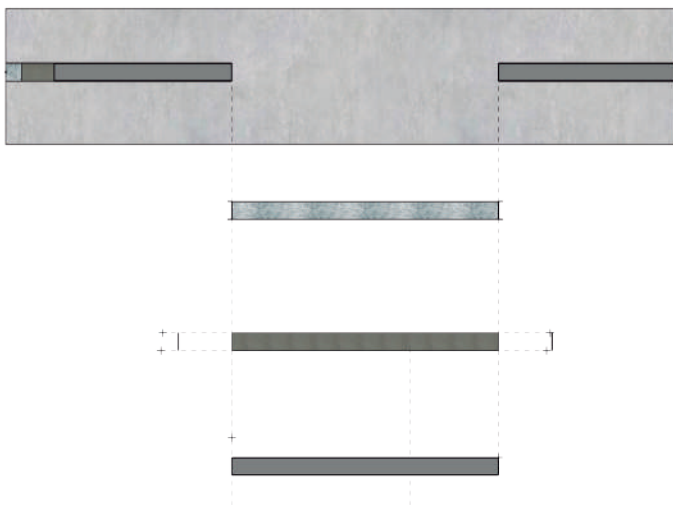
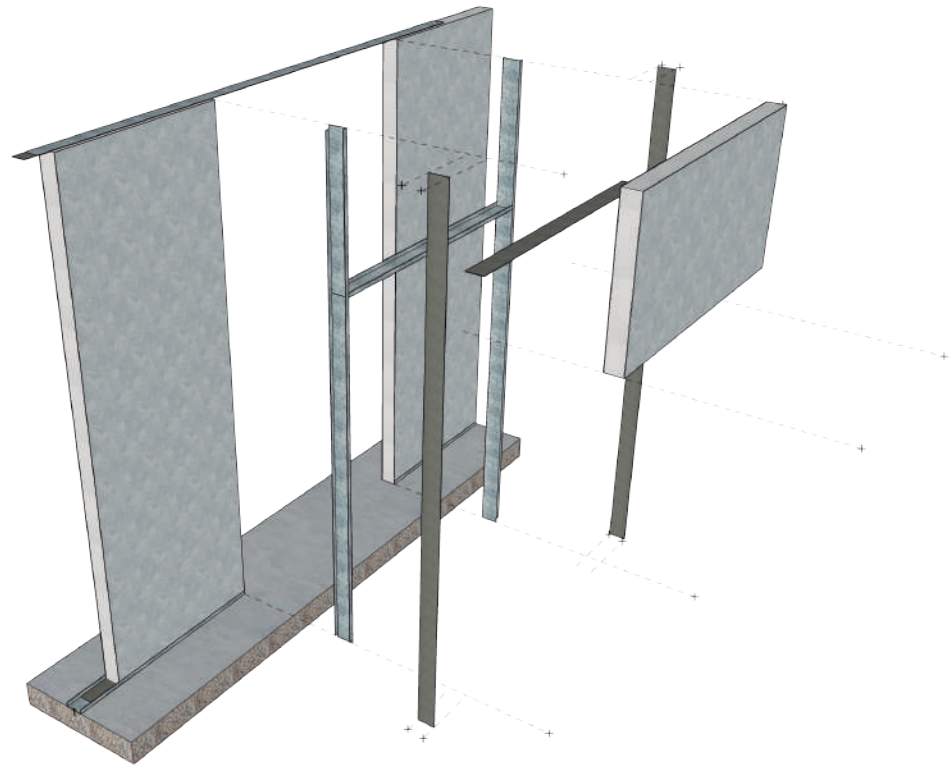

DÉTAIL DE LA RÉUNION PANEL-PANEL

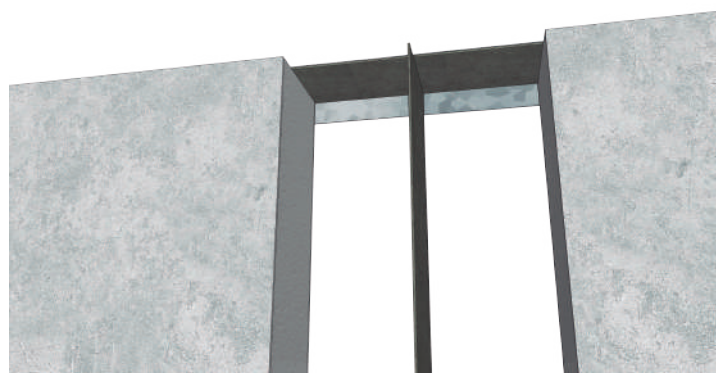
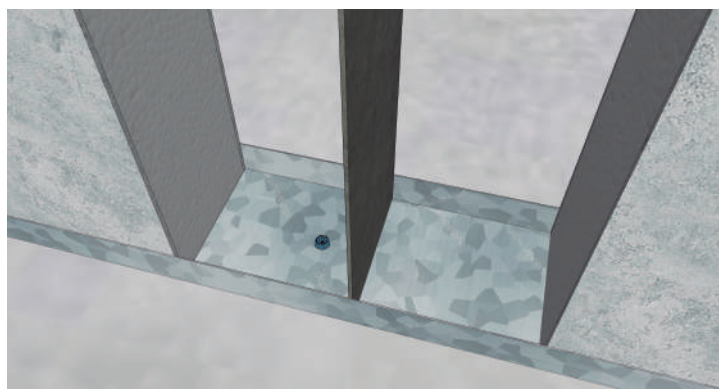
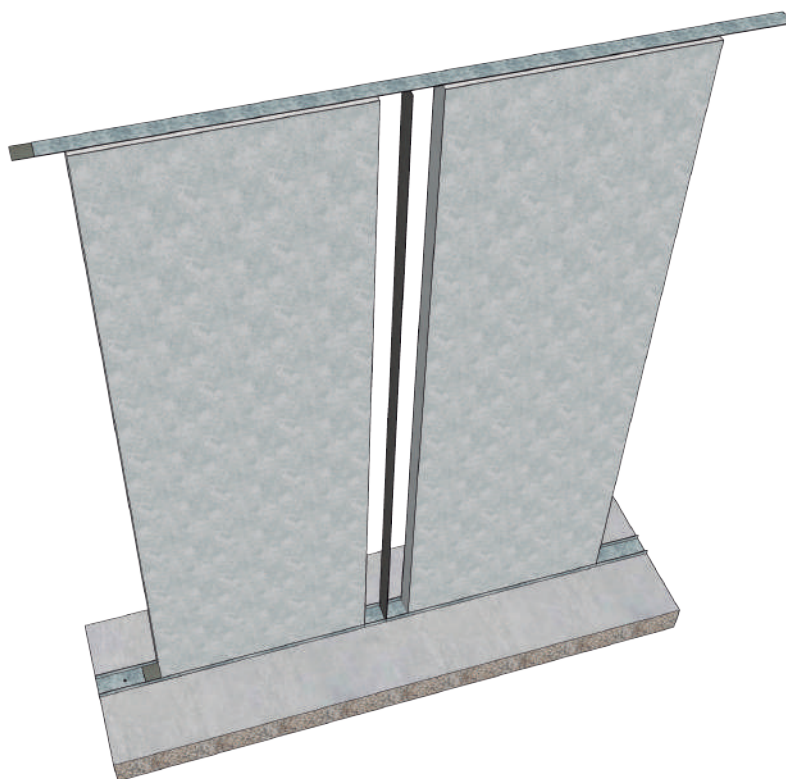

España
☎ +34868128999
+34619199399
📞 +34606852013

Estados Unidos
📞 +1 407 413 9329

Panamá
☎ +507 833 7662

DÉTAIL DE RENFORCEMENT SPÉCIAL EN H (Fenêtres ou Placards)

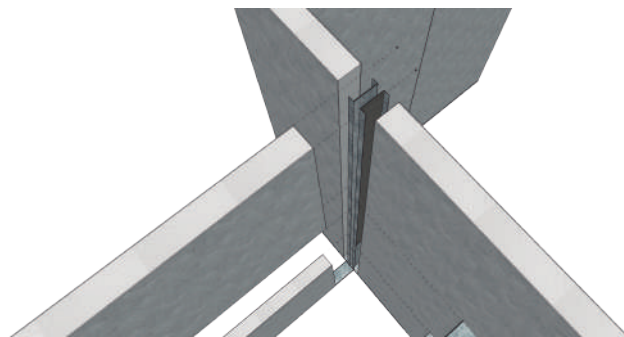
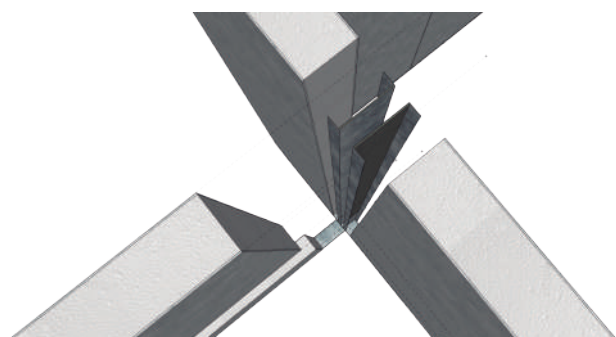
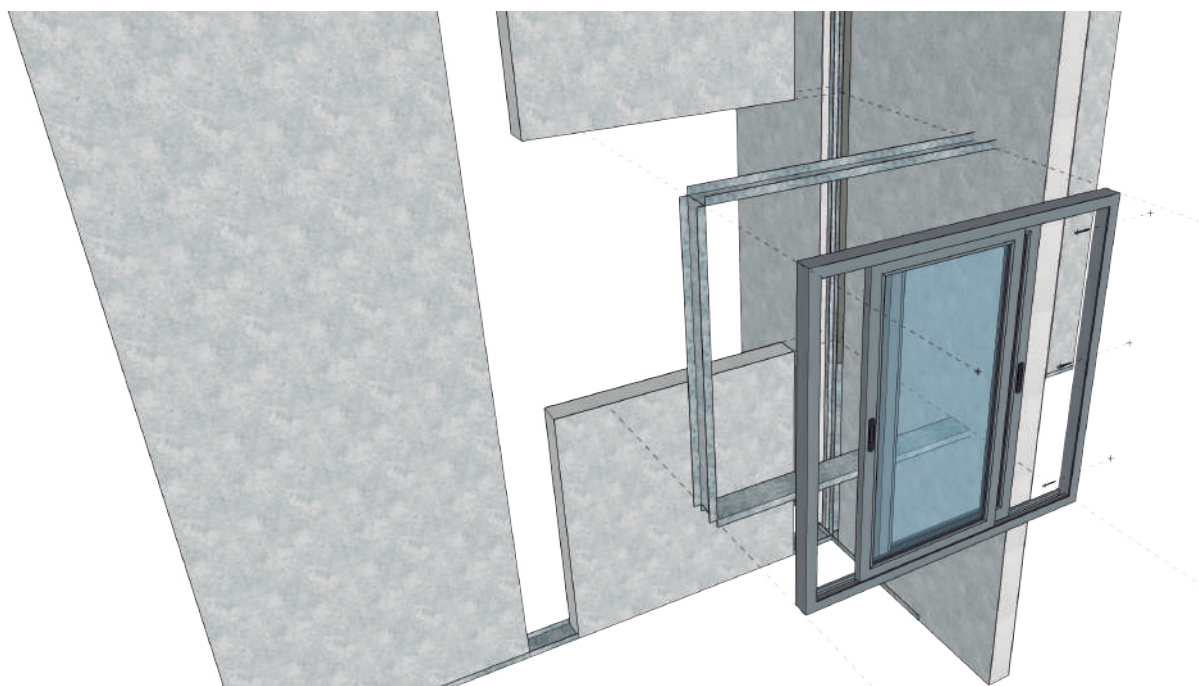

España

+34868128999
+34619199399
+34606852013

Estados Unidos

+1 407 413 9329

Panamá

+507 833 7662

DÉTAIL D'ANCRAGE DU PANNEAU AU PLAFOND (Cloison int. Béton St.)



DÉTAIL DU PANNEAU - RENCONTRE DE PORTE

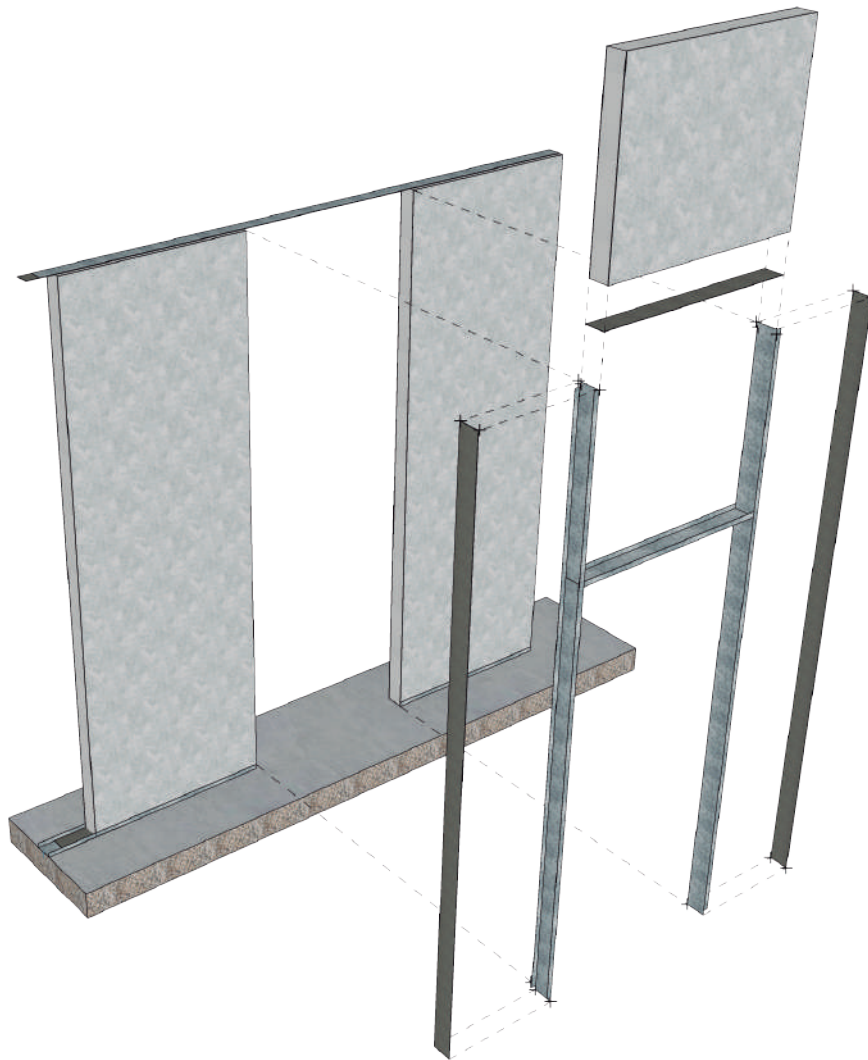

España
☎ +34868128999
☎ +34619199399
☎ +34606852013

Estados Unidos
☎ +1 407 413 9329

Panamá
☎ +507 833 7662

DET. D'ANCRAGE DU PANNEAU AU SOL (Ext. Façade Est. Metalica)

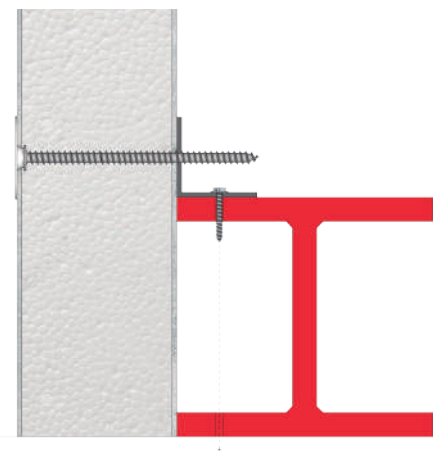
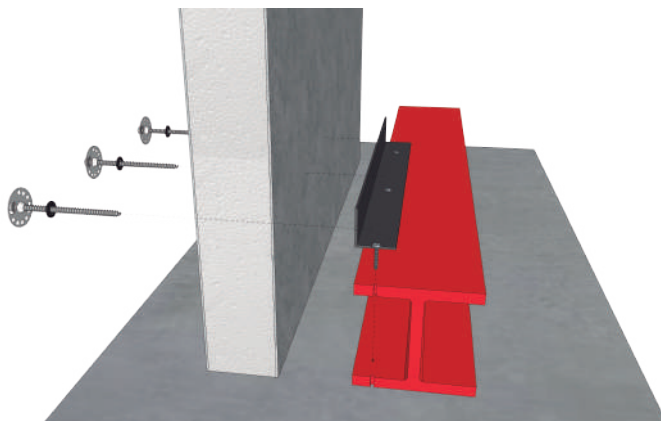
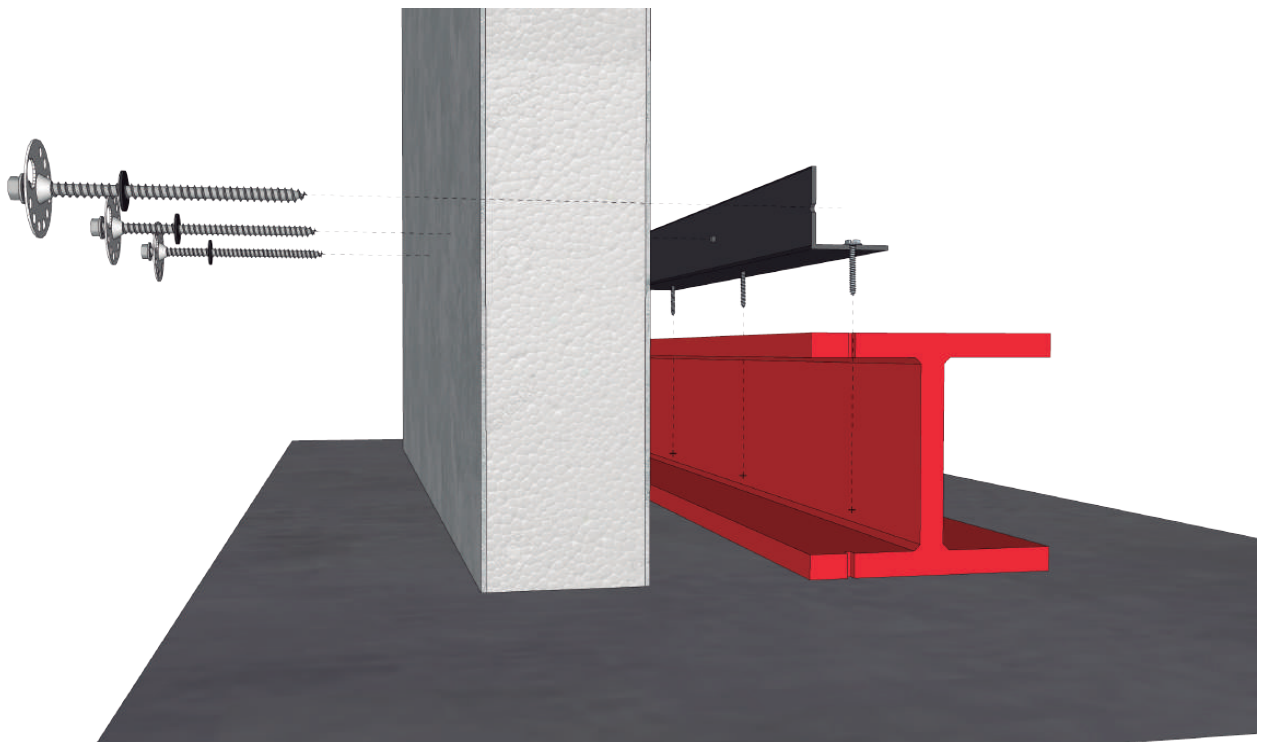

España

+34868128999
+34619199399
+34606852013

Estados Unidos

+1 407 413 9329

Panamá

+507 833 7662

DÉTAIL DE LA RÉUNION DU PANNEAU D'ANGLE

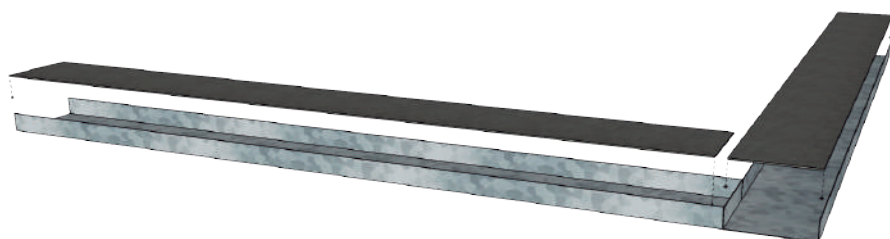
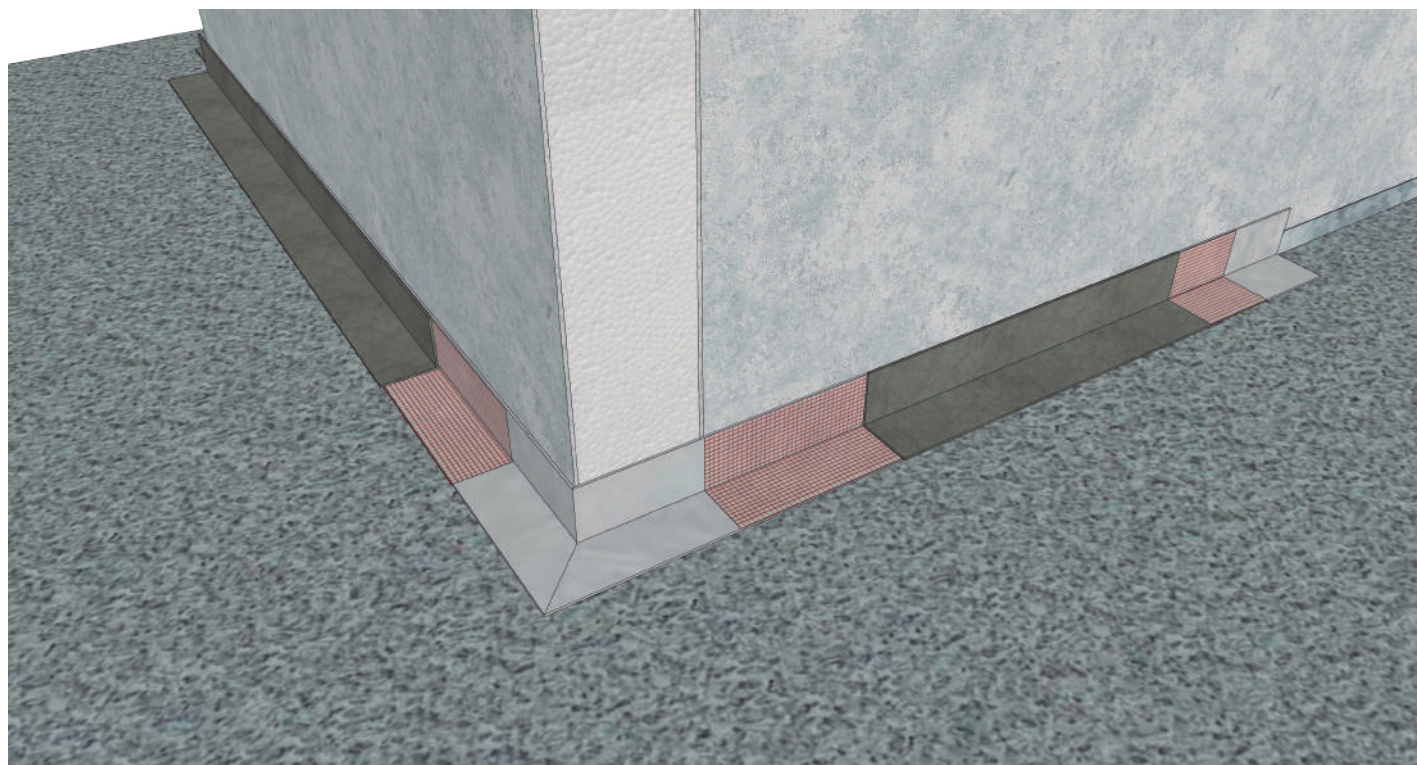

España

+34868128999
+34619199399
+34606852013

Estados Unidos

+1 407 413 9329

Panamá

+507 833 7662

DÉTAIL DU PANNEAU D'ANCRAGE AUL SOL (Cloisonnement Int. Rue Béton)

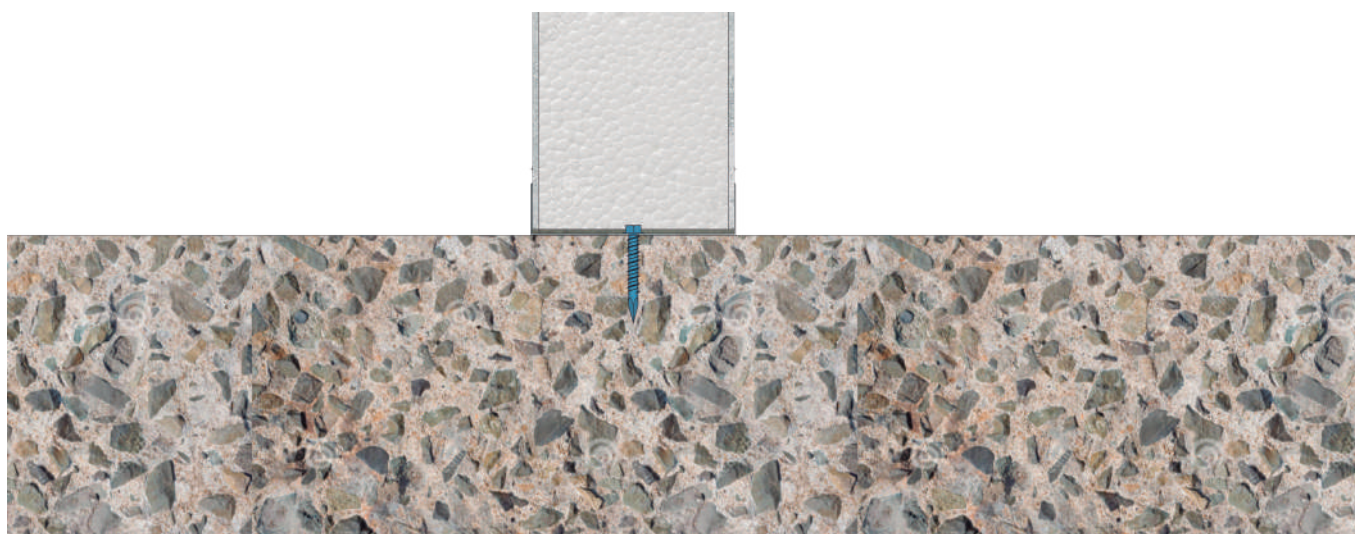
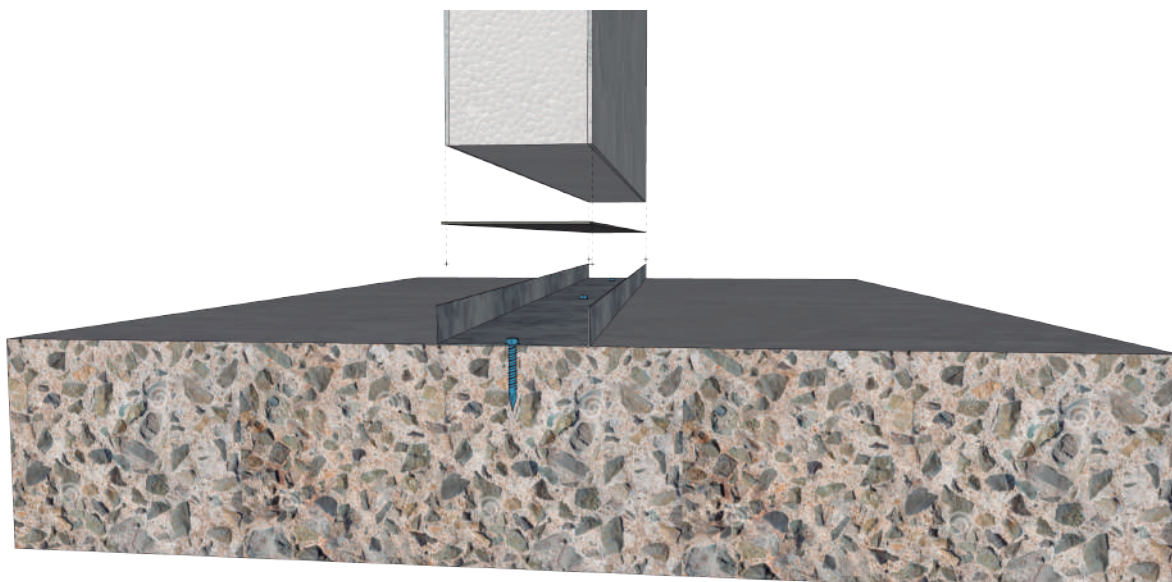

España

+34868128999
+34619199399
+34606852013

Estados Unidos

+1 407 413 9329

Panamá

+507 833 7662

DÉTAIL DU PANNEAU D'ANCRAGE AU SOL (Cloisonnage Int. Metal Est.)

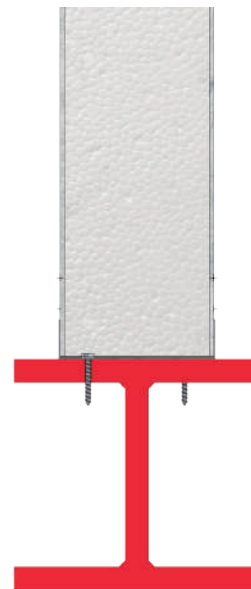
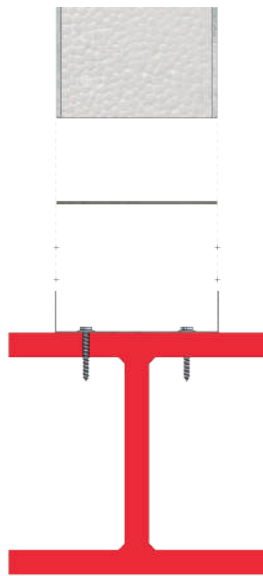
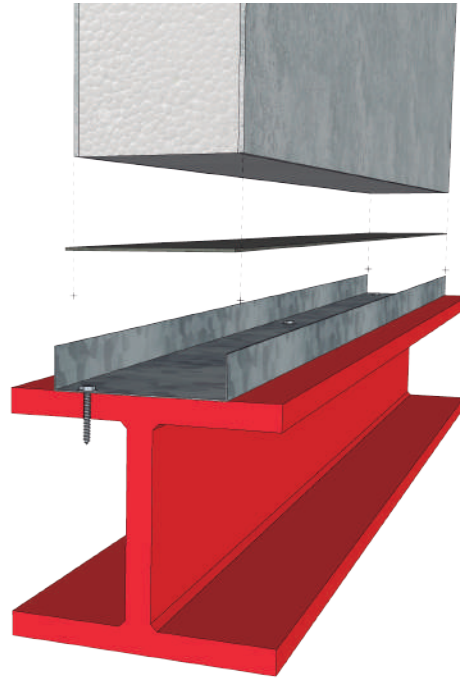

España

+34868128999
+34619199399
+34606852013

Estados Unidos

+1 407 413 9329

Panamá

+507 833 7662

DÉTAIL DU PANNEAU D'ANCRAGE AUD PLAFOND (Métal Est. Int. Façade)

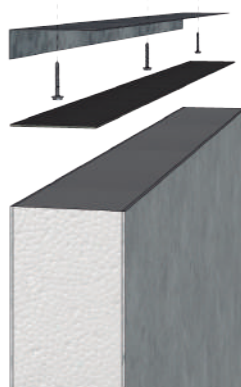
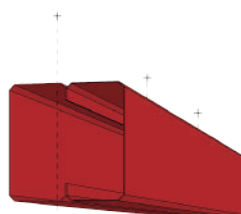
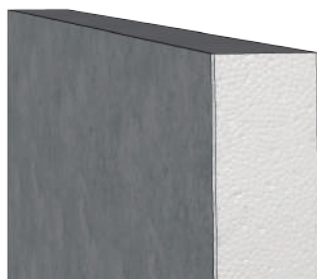
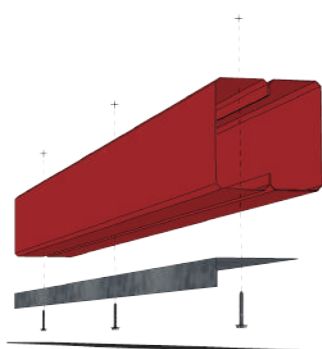

España

+34868128999
+34619199399
+34606852013

Estados Unidos

+1 407 413 9329

Panamá

+507 833 7662

DÉTAIL DE LA RÉUNION PANEL-COLONNE

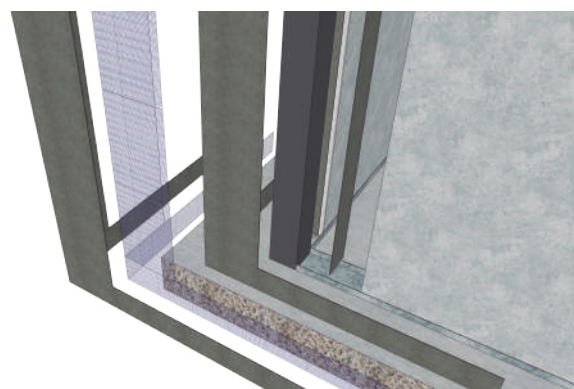
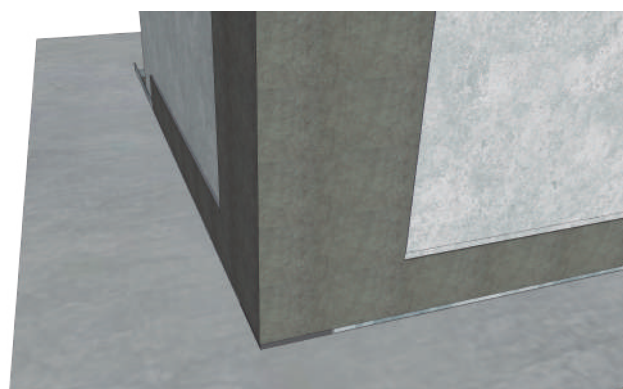
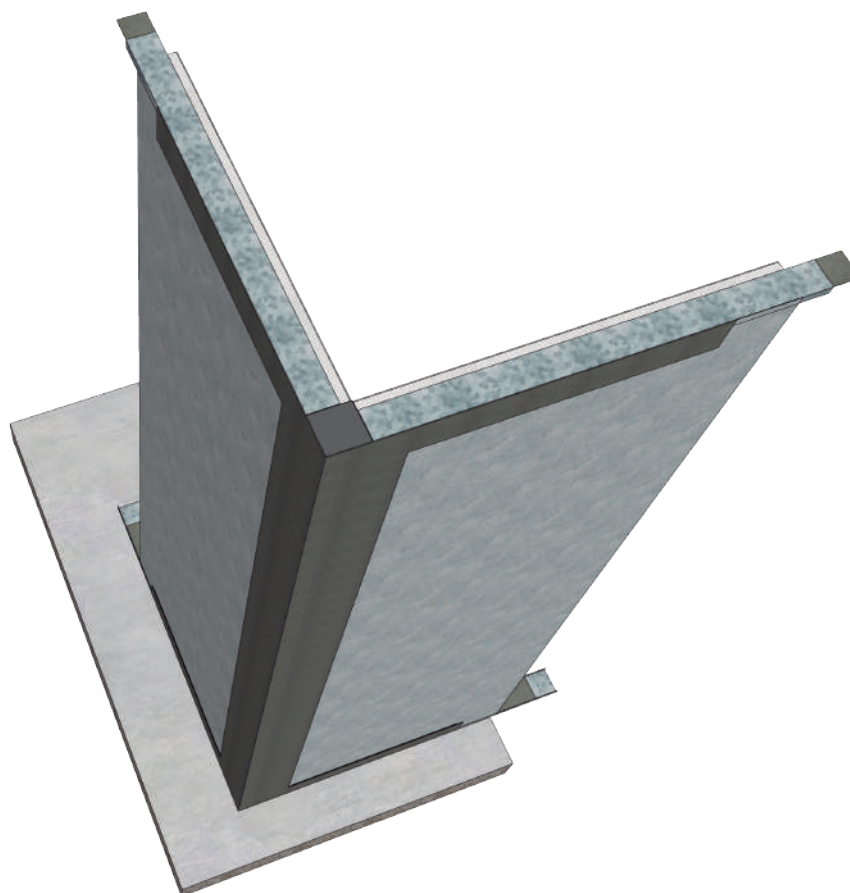

España

+34868128999
+34619199399
+34606852013

Estados Unidos

+1 407 413 9329

Panamá

+507 833 7662

DÉTAIL DE RENFORT DANS LES FENÊTRES

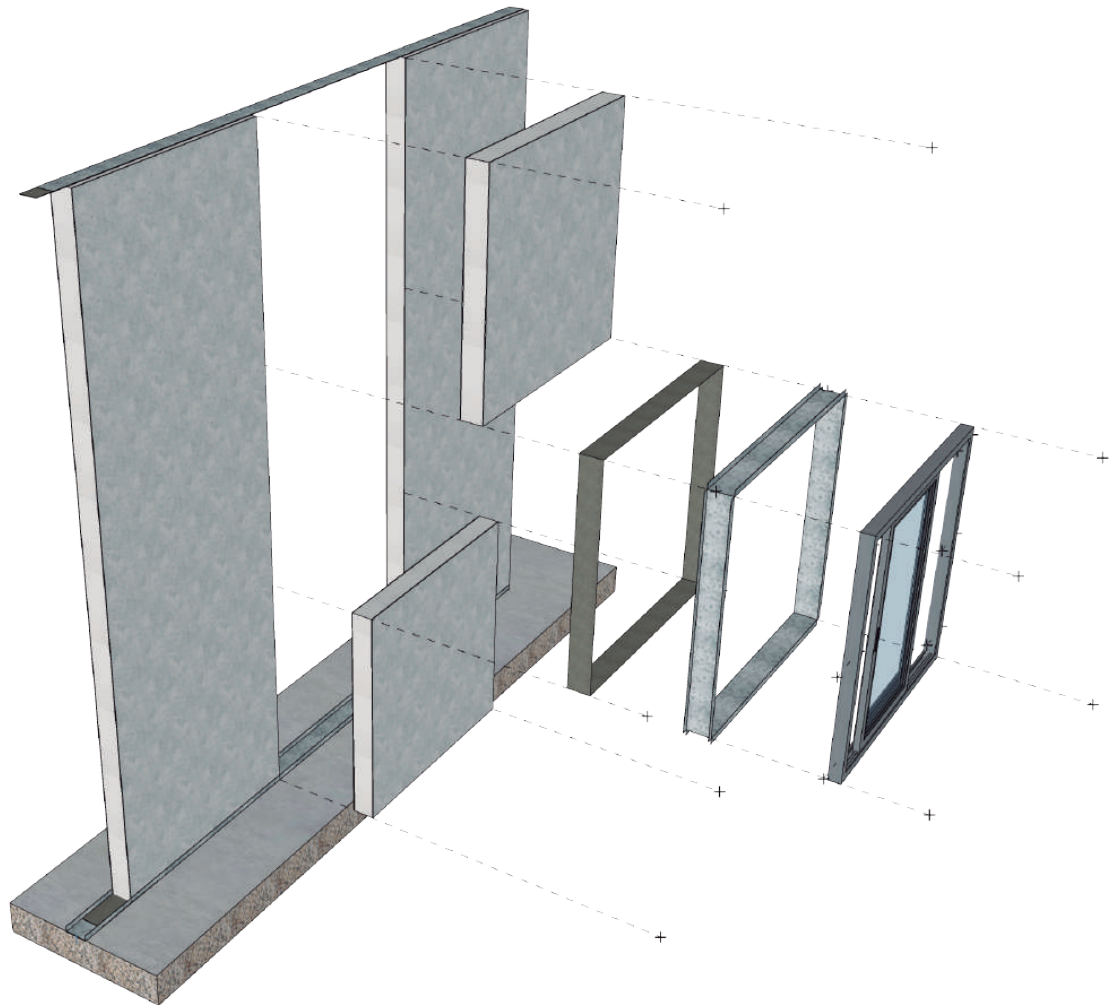

España

+34868128999
+34619199399
+34606852013

Estados Unidos

+1 407 413 9329

Panamá

+507 833 7662

JAM DETAIL

(Pour les bords de dalle ou l'ancrage de garde-corps ou de fenêtres)

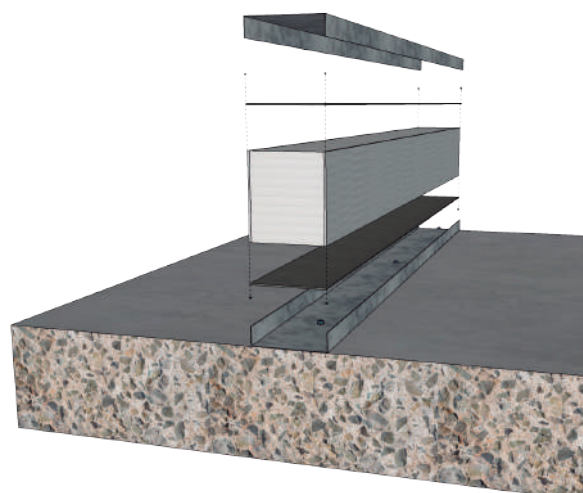
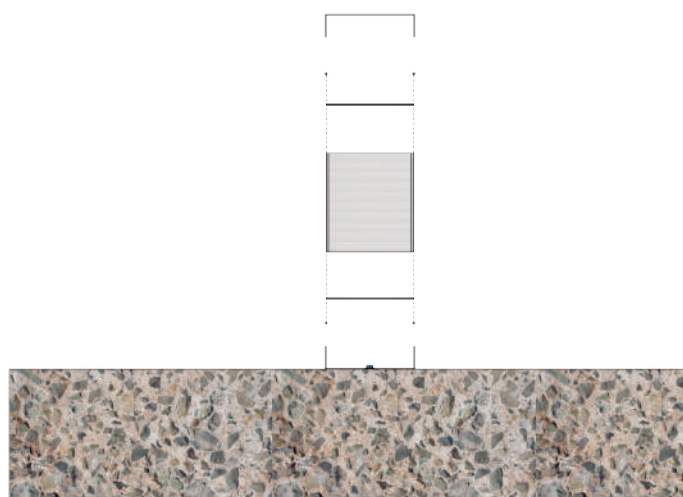
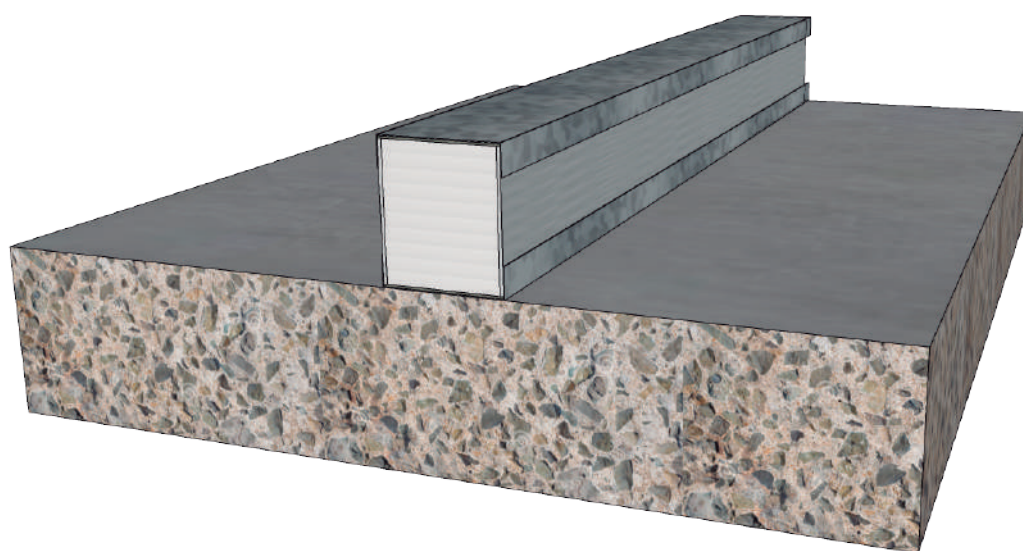

DÉTAIL DE RENFORT SUR LES PORTES

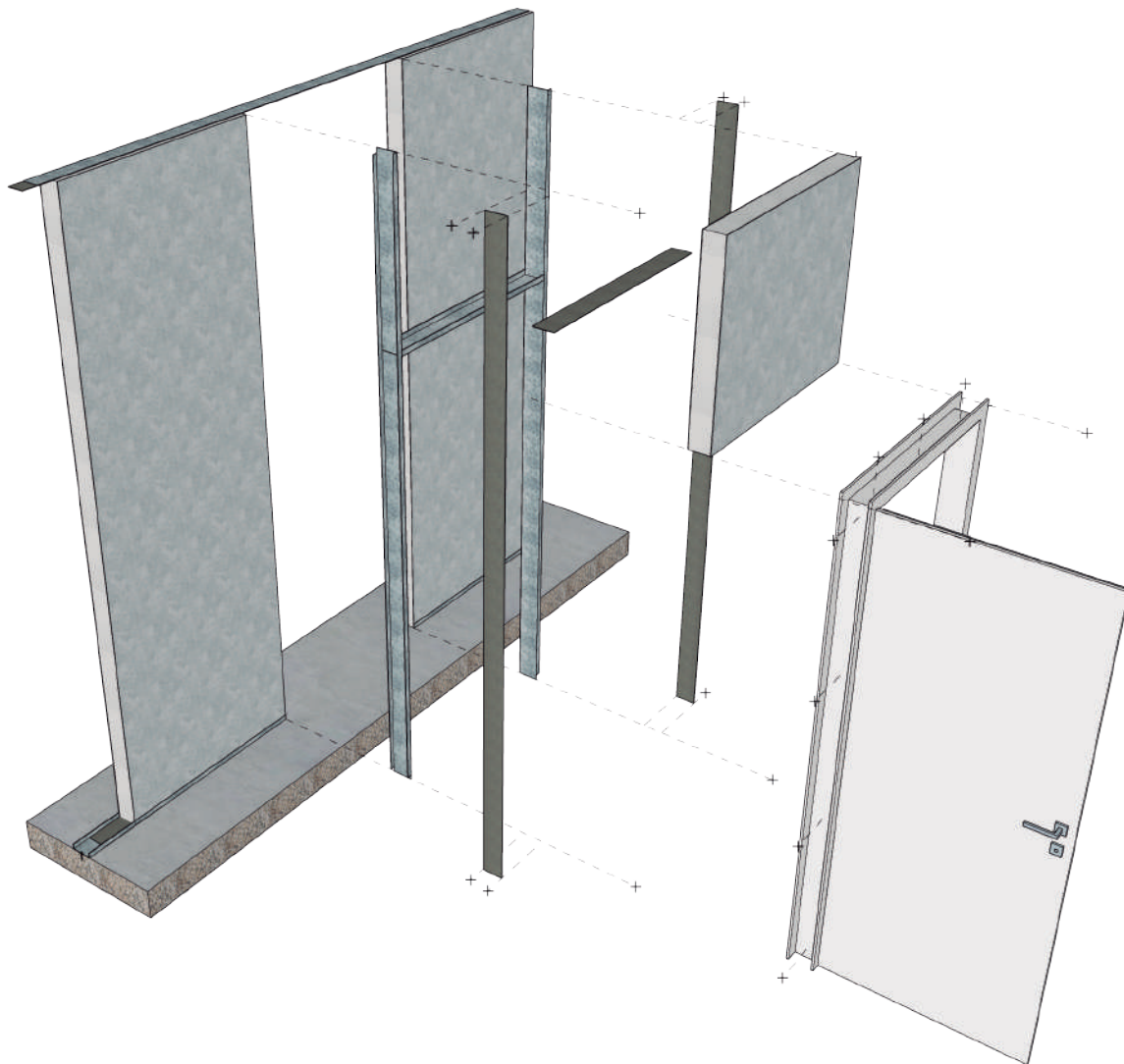

España
☎ +34868128999
☎ +34619199399
☎ +34606852013

Estados Unidos
☎ +1 407 413 9329

Panamá
☎ +507 833 7662

DÉTAIL DE RENFORT SPÉCIAL EN L (Pour huisseries ou placards)

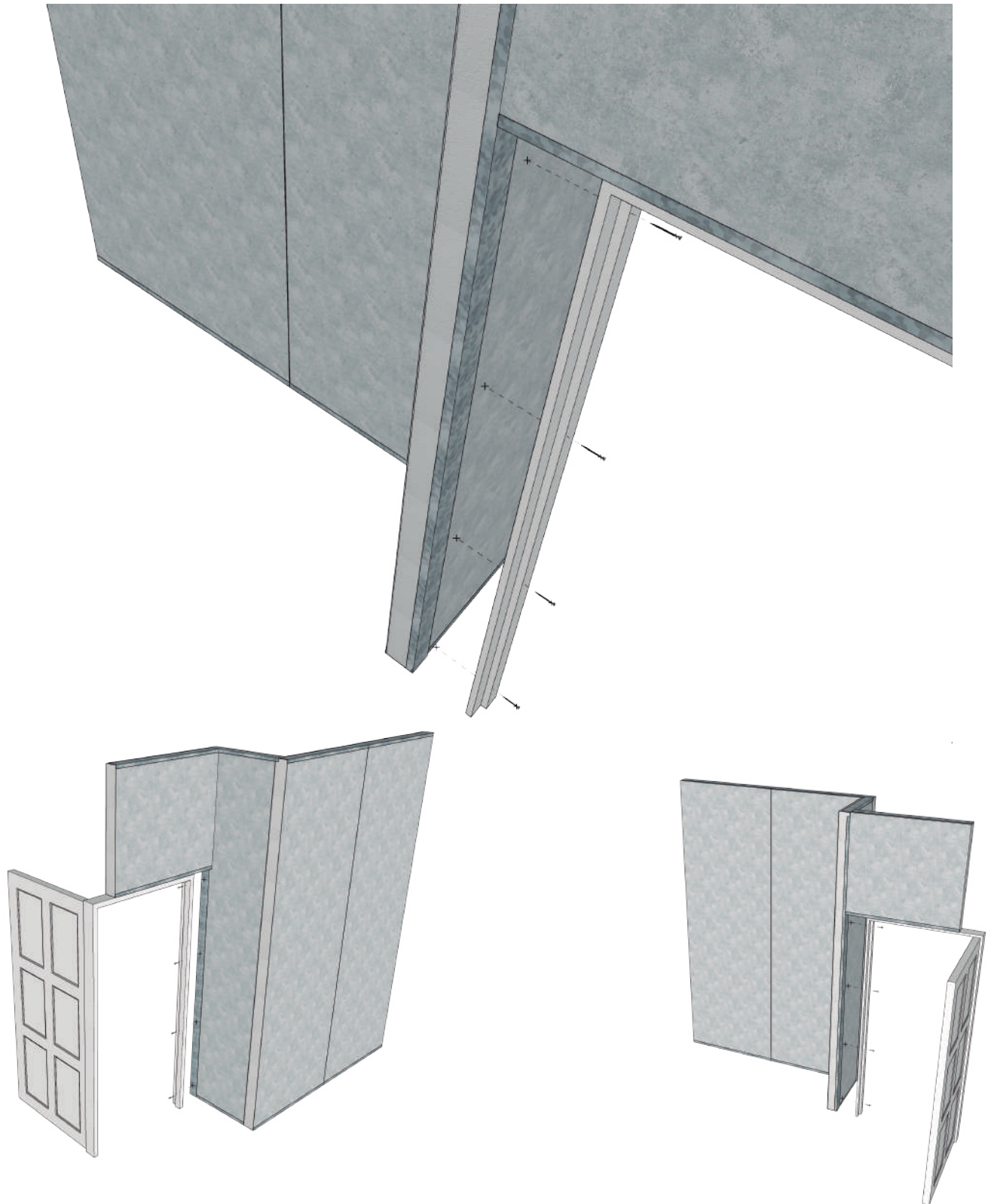

España

+34868128999
+34619199399
+34606852013

Estados Unidos

+1 407 413 9329

Panamá

+507 833 7662

DÉTAIL SPÉCIAL RENFORT POUSSETTE DOUBLE

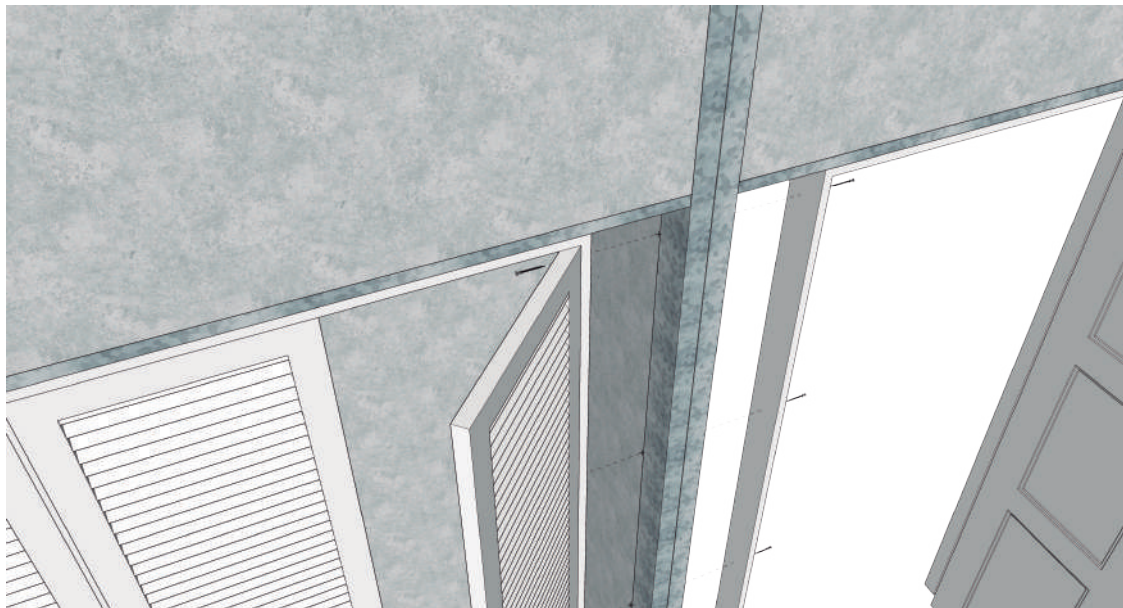
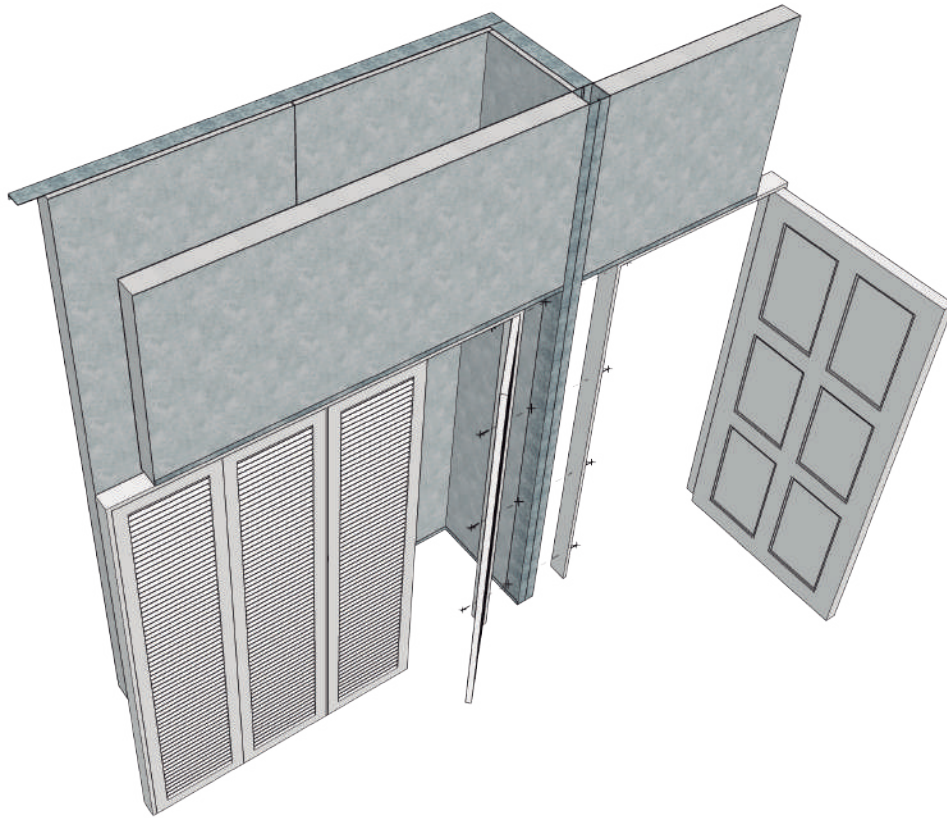

España

+34868128999
+34619199399
+34606852013

Estados Unidos

+1 407 413 9329

Panamá

+507 833 7662

DÉTAIL DE LA RENCONTRE PANNEAU-FENÊTRE

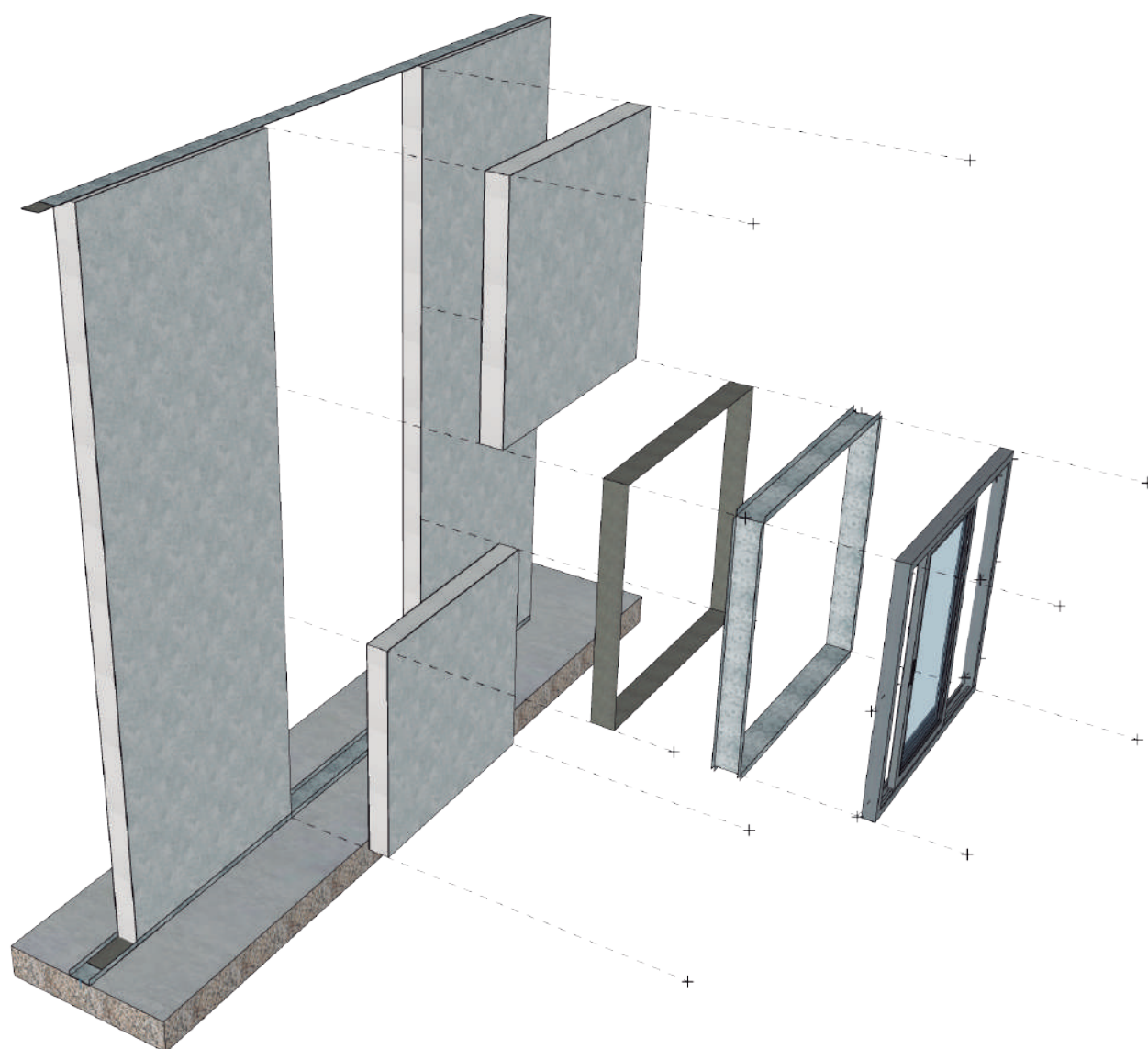

España

+34868128999
+34619199399
+34606852013

Estados Unidos

+1 407 413 9329

Panamá

+507 833 7662

DÉTAIL DES JOINTS DE SURFACE AUX JOINTS D'ANGLE

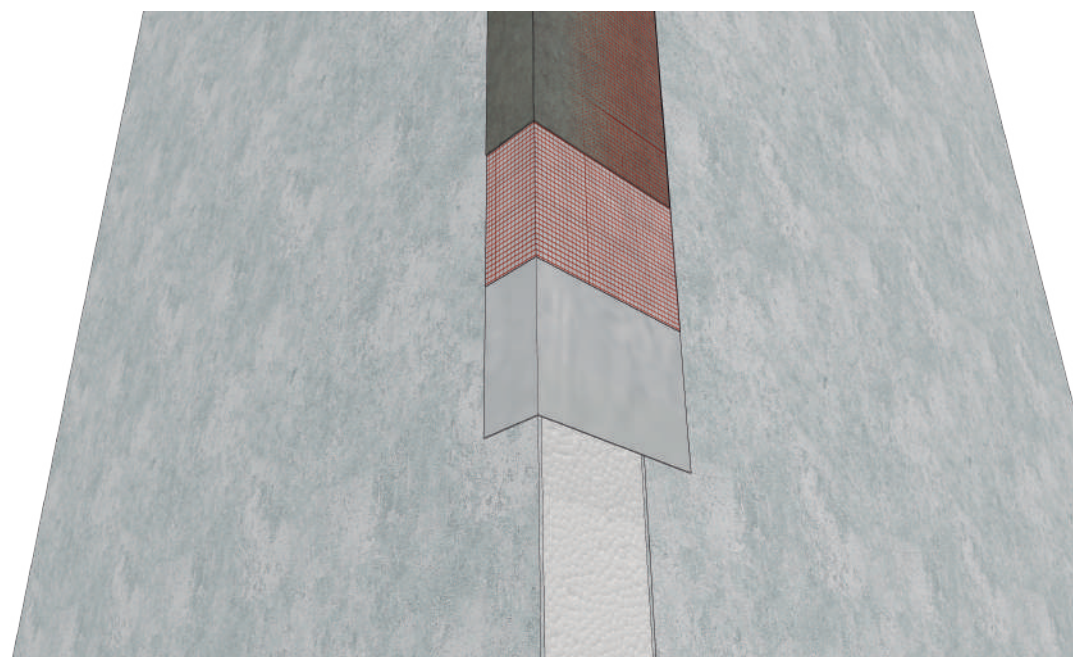
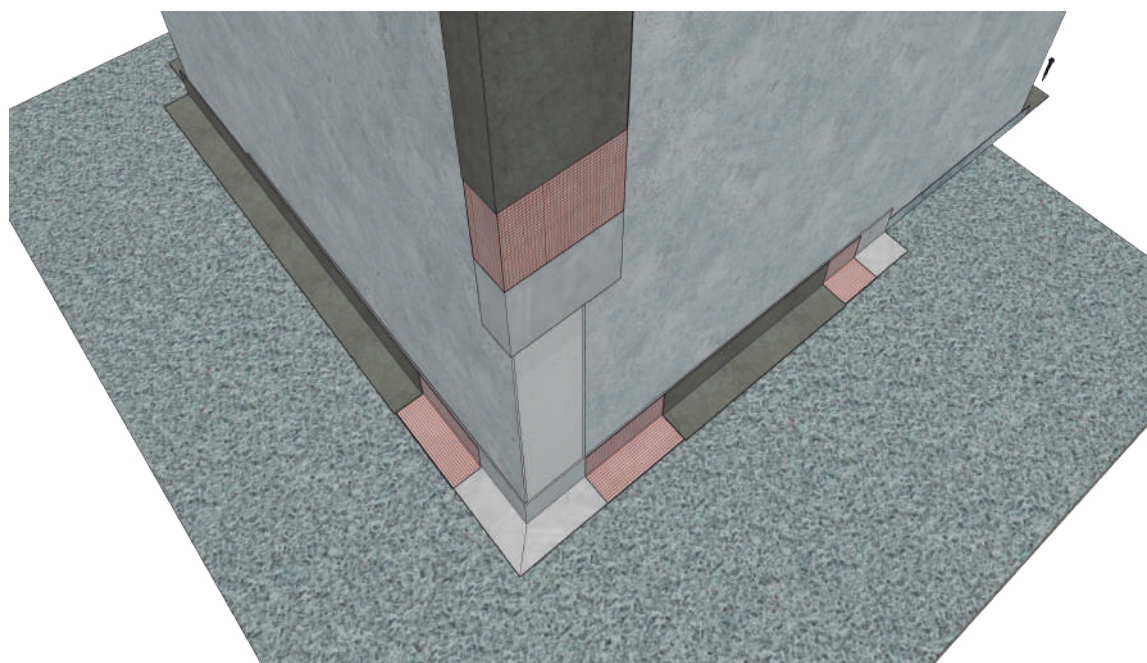

España

+34868128999
+34619199399
+34606852013

Estados Unidos

+1 407 413 9329

Panamá

+507 833 7662

DÉTAIL DU PANNEAU D'ANCRAGE AUT TOIT (Ext. Façade Est. Concreto)

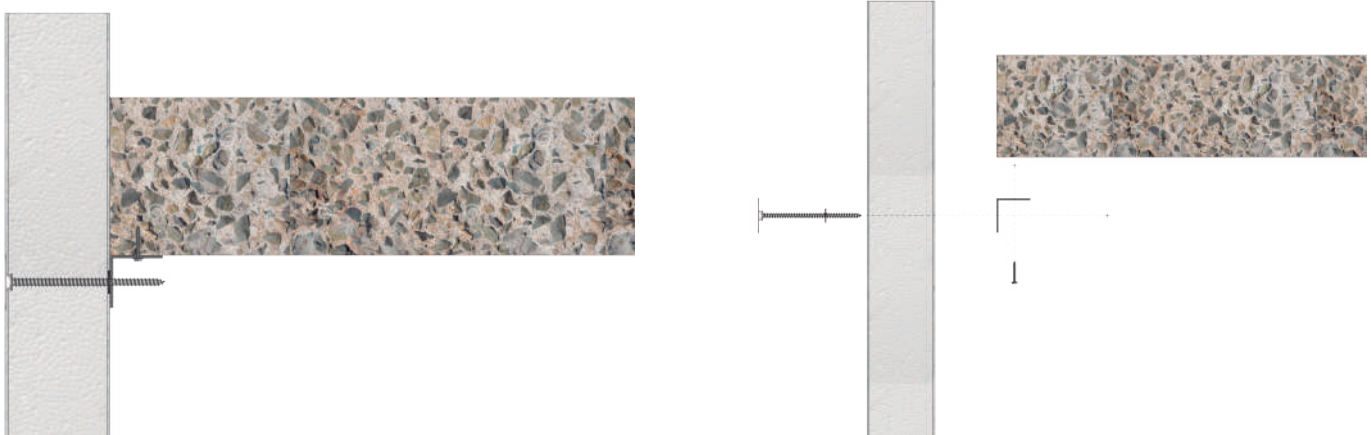
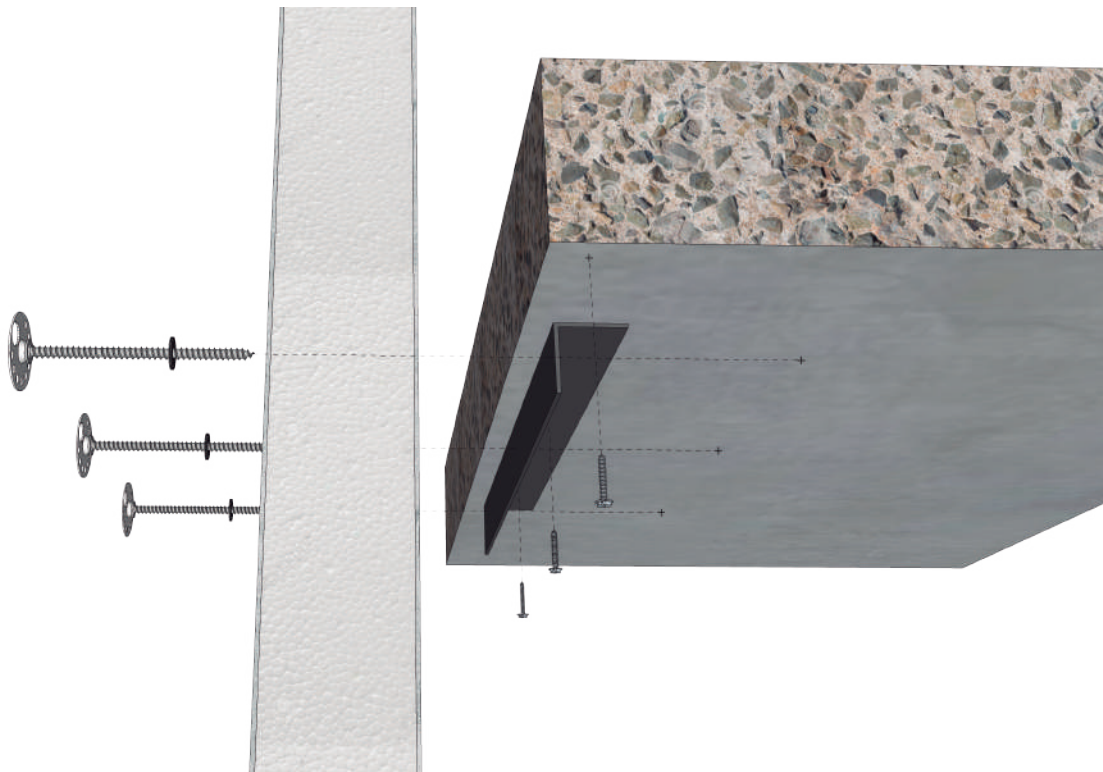

DÉTAIL DU PANNEAU D'ANCRAGE AUT TOIT (Ext. Façade Est. Metalica)

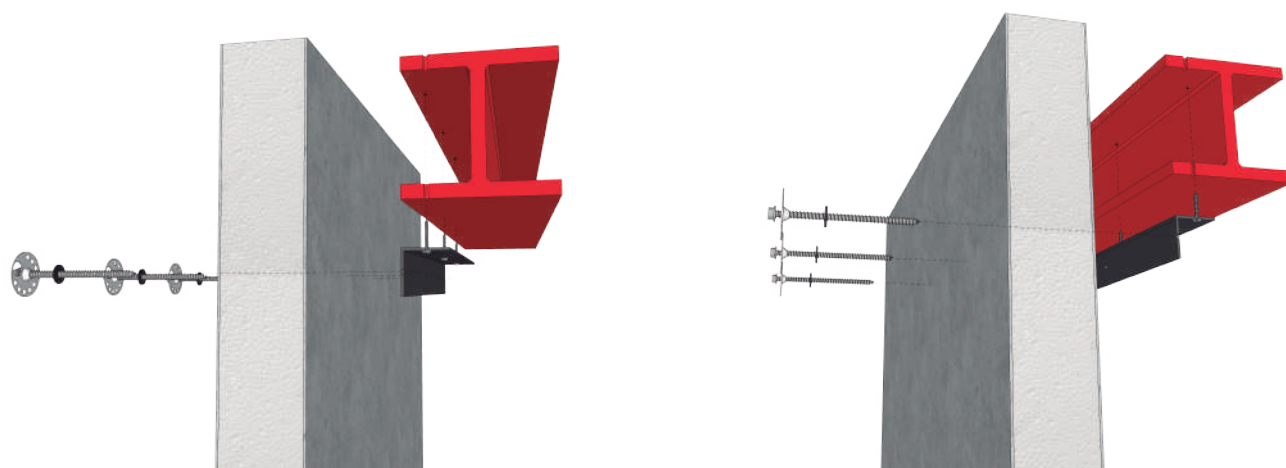
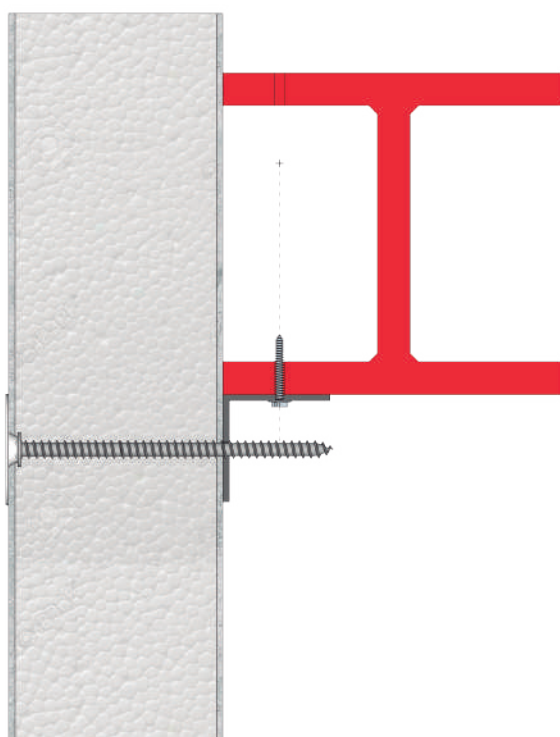

España

+34868128999
+34619199399
+34606852013

Estados Unidos

+1 407 413 9329

Panamá

+507 833 7662

DÉTAIL DU PANNEAU D'ANCRAGE AULSOL (Ext. Façade Est. Concreto)

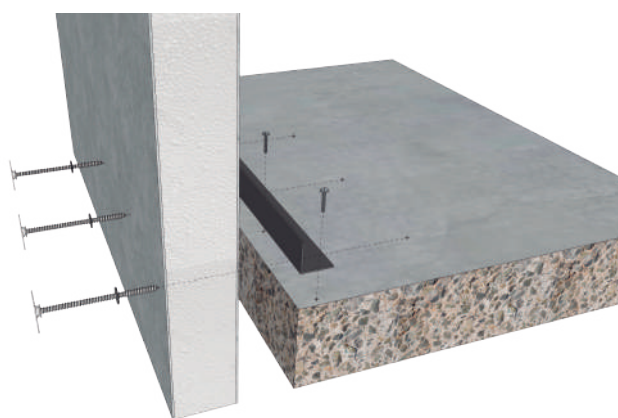

España

+34868128999
+34619199399
+34606852013

Estados Unidos

+1 407 413 9329

Panamá

+507 833 7662

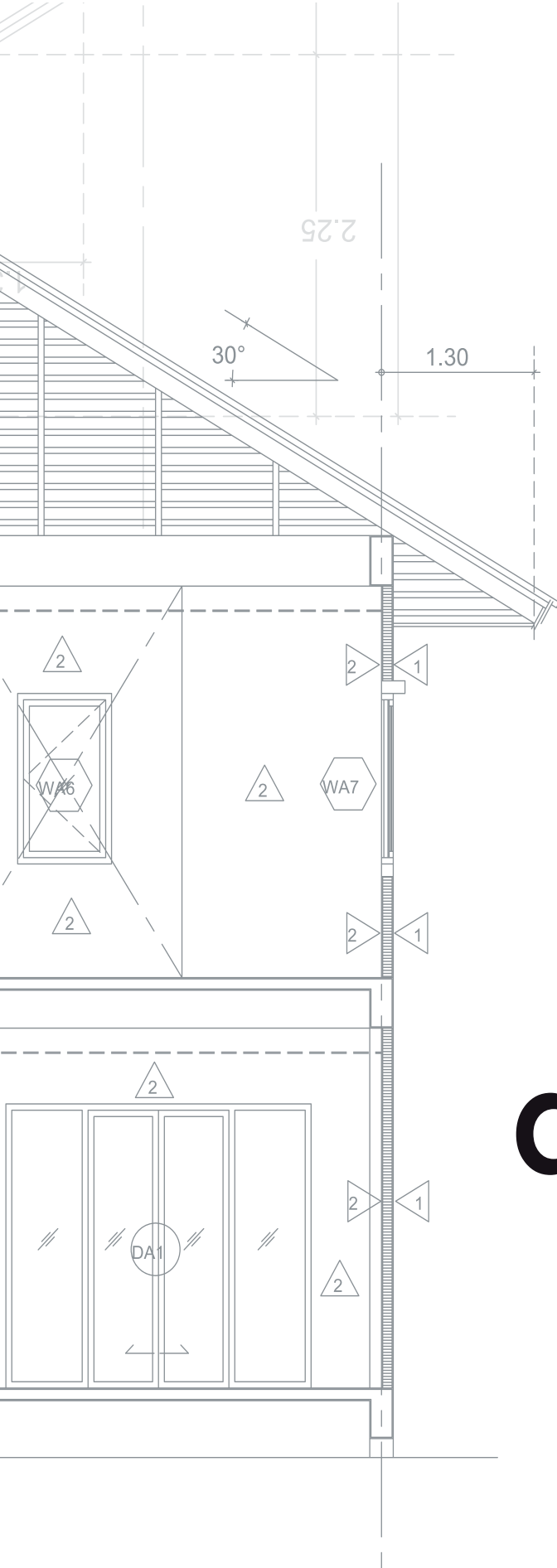

quïckplâck[®]

España

+34868128999

+34619199399

+34606852013

Panamá

+507 833 7662

Estados Unidos

+1 407 413 9329

quickplack@quickplack.com

www.quickplack.com