



quickmolding

Get an excellent
final finish and
decorative in very
short time.



quickmolding is a product born to solve with ease the constructive details both in modern architecture and in traditional architecture, avoiding some problems that were usually created during construction with the use of traditional products.

The base material of which quickmolding is composed is EPS (expanded polystyrene) and XPS (extruded polystyrene) of high density material well known for its excellent insulating properties that gives it the required volume with reduced weights.

quickmolding It is presented with a surface finish in elastomeric mortar if you want to have an aesthetic behavior similar to stone, concrete, classic paints, etc.

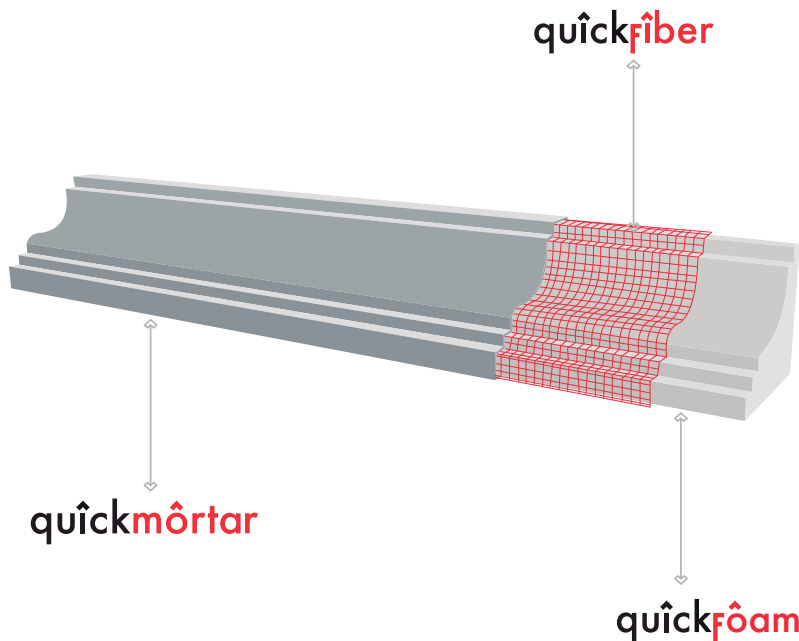

Advantage.

- ◇ Wide range of designs.
- ◇ Strength before the climatic changes.
- ◇ Adaptation to different systems.
- ◇ Resistance and lightness.
- ◇ Custom designs.
- ◇ A fi nity with different finishes.
- ◇ Stability and low cost.
- ◇ Easy installation.

España

+34868128999
+34619199399
+34606852013

Estados Unidos

+1 407 413 9329

Panamá

+507 833 7662

BANQUINES

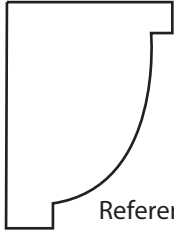

Reference 001



Reference 002



Reference 003

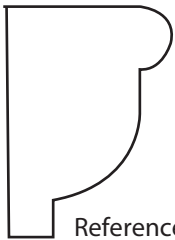

Reference 004

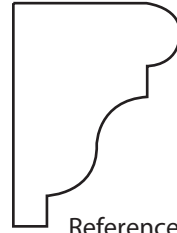

Reference 005

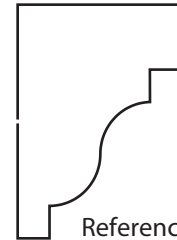

Reference 006

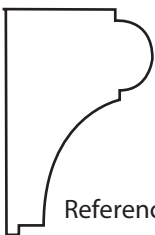

Reference 007



Reference 008



Reference 009

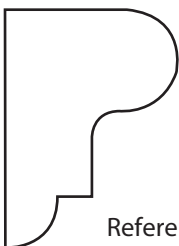

Reference 010

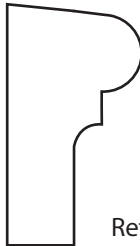

Reference 011

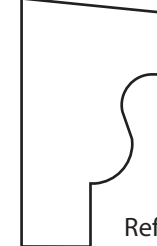

Reference 012

España

+34868128999
+34619199399
+34606852013

Estados Unidos

+1 407 413 9329

Panamá

+507 833 7662



BORDES



Reference 013

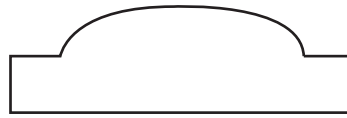

Reference 014

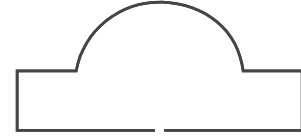

Reference 015



Reference 016



Reference 017

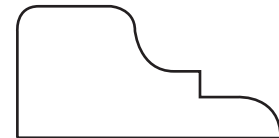

Reference 018

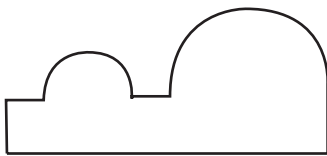

Reference 019



Reference 020



Reference 021

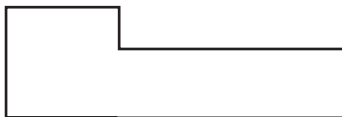

Reference 022



Reference 023



Reference 024

España

+34868128999
+34619199399
+34606852013













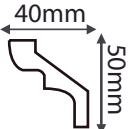

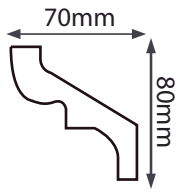
Estados Unidos

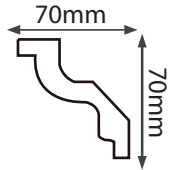
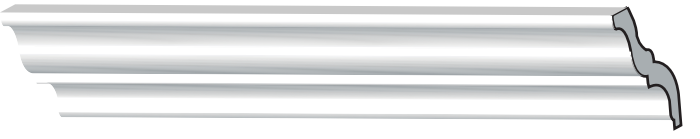
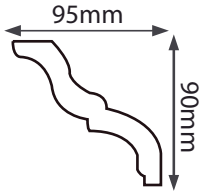

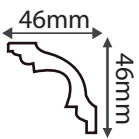
+1 407 413 9329

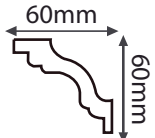
Panamá

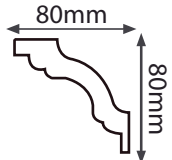
+507 833 7662

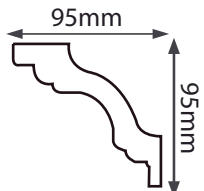
CORNISAS

	Reference 025	
	Reference 026	
	Reference 027	
	Reference 028	
	Reference 029	
	Reference 030	
	Reference 031	
	Reference 032	
	Reference 033	

España
 +34868128999
 +34619199399
 +34606852013

Estados Unidos
 +1 407 413 9329

Panamá
 +507 833 7662



CORNISAS

	Reference 034	
	Reference 035	
	Reference 036	
	Reference 037	
	Reference 038	
	Reference 039	
	Reference 040	
	Reference 041	
	Reference 042	

España

+34868128999
+34619199399
+34606852013

Estados Unidos

+1 407 413 9329

Panamá

+507 833 7662



Cornisas



Reference 043

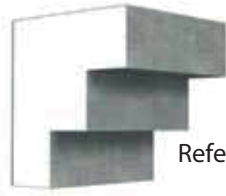

Reference 049



Reference 044



Reference 050



Reference 045



Reference 051



Reference 046

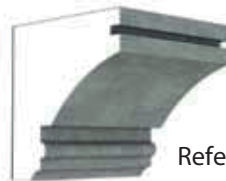

Reference 052



Reference 047



Reference 053



Reference 048



Reference 054

Corbels



Reference 050



Reference 051

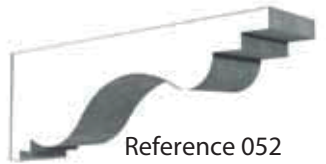

Reference 052

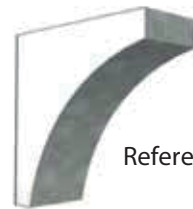

Reference 053



Reference 054



Reference 055

España

+34868128999
+34619199399
+34606852013

Estados Unidos

+1 407 413 9329

Panamá

+507 833 7662

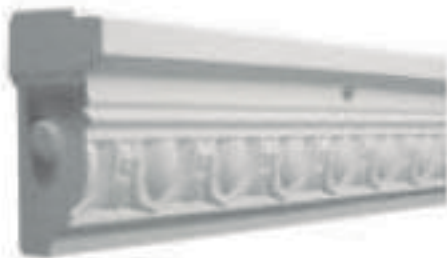

Reference 056



Reference 060



Reference 057



Reference 061



Reference 058



Reference 062



Reference 059



Reference 063

España

+34868128999
+34619199399
+34606852013

Estados Unidos

+1 407 413 9329

Panamá

+507 833 7662



Reference 064



Reference 065



Reference 066



Reference 067



Reference 068



Reference 069



Reference 070



Reference 071



Reference 072



Reference 073



Reference 074

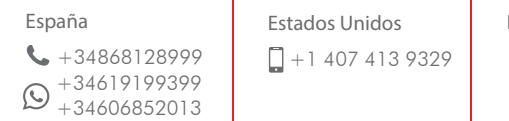

Reference 075



Reference 076



Reference 077



Reference 078



Reference 079



Reference 080



Reference 081



Reference 082



Reference 083



Reference 084



Reference 085



Reference 086



Reference 087



Reference 088



Reference 089

Reference 090

Reference 091

Reference 092

Reference 093

España

+34868128999
+34619199399
+34606852013

Estados Unidos

+1 407 413 9329

Panamá

+507 833 7662

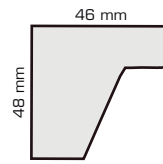

Reference 094

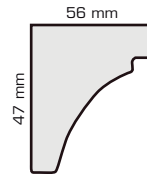

Reference 095

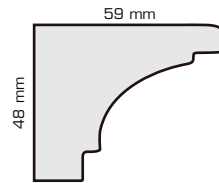

Reference 096

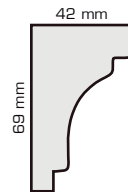

Reference 097

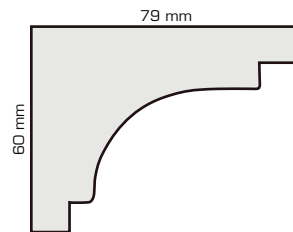



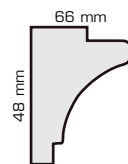



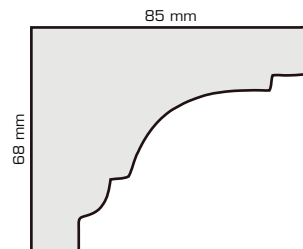

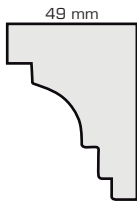
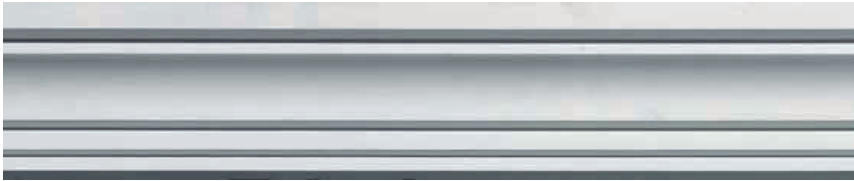
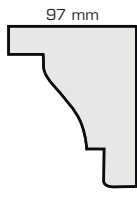

Reference 098

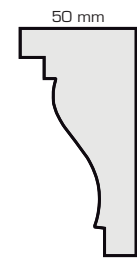
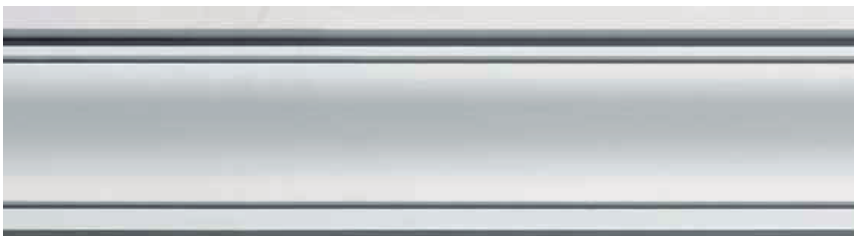
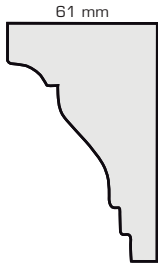

Reference 099

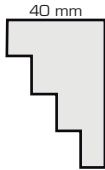

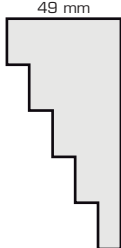
Reference 100

Reference 101	 <p>49 mm</p>	
Reference 102	 <p>97 mm</p>	
Reference 103	 <p>50 mm</p>	
Reference 104	 <p>61 mm</p>	
Reference 105	 <p>30 mm</p>	
Reference 106	 <p>40 mm</p>	
Reference 107	 <p>49 mm</p>	



COLUMNS



Ref.: 108
Fluted column part
168 cm
Ø 13 cm



Ref.: 109
Fluted column part
110 cm
Ø 18 cm



Ref.: 110
Fluted column part
193 cm
Ø 18 cm



Ref.: 111
Fluted column part
177 cm
Ø 20 cm



Ref.: 112
Conical column piece
159 cm
Ø 15 cm

España

+34868128999
+34619199399
+34606852013

Estados Unidos

+1 407 413 9329

Panamá

+507 833 7662

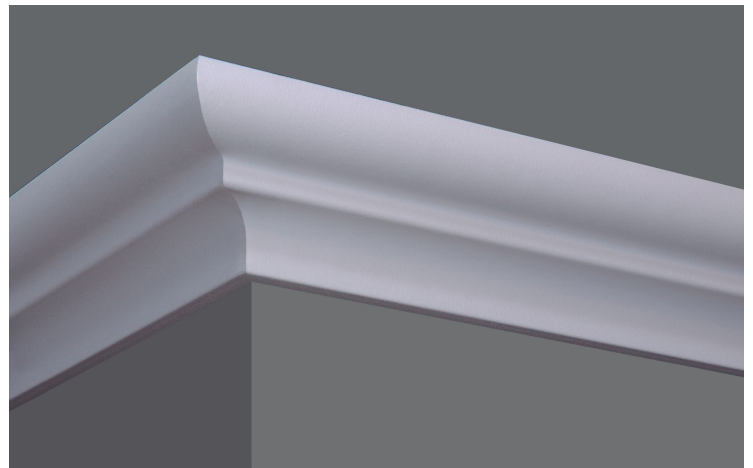
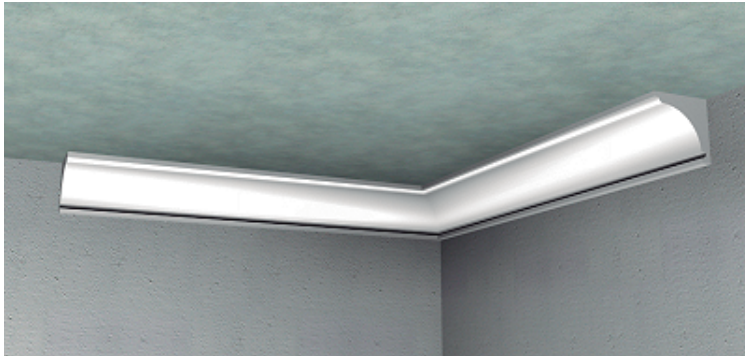
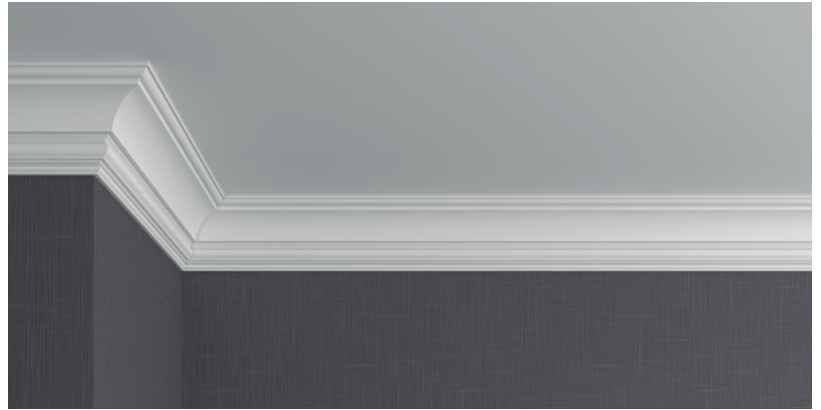
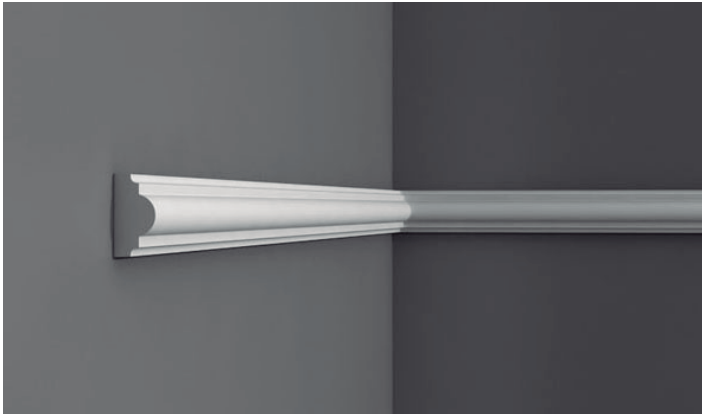

España

+34868128999
+34619199399
+34606852013

Estados Unidos

+1 407 413 9329

Panamá

+507 833 7662

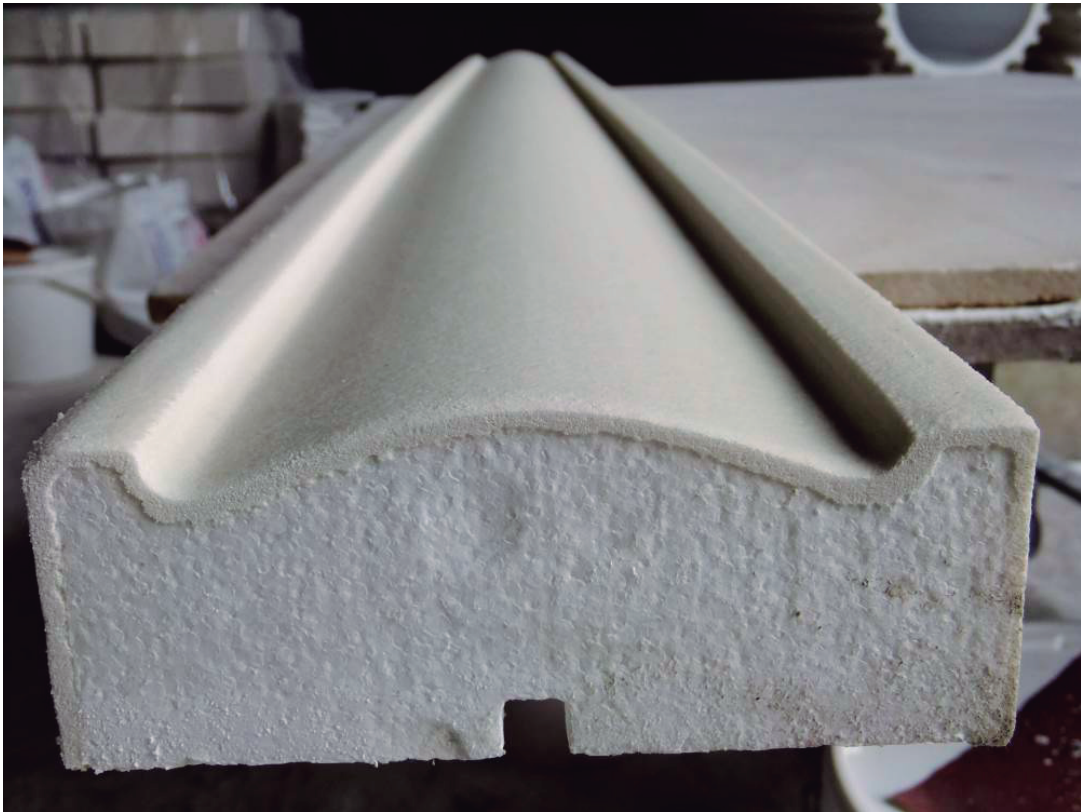

España

+34868128999
+34619199399
+34606852013

Estados Unidos

+1 407 413 9329

Panamá

+507 833 7662

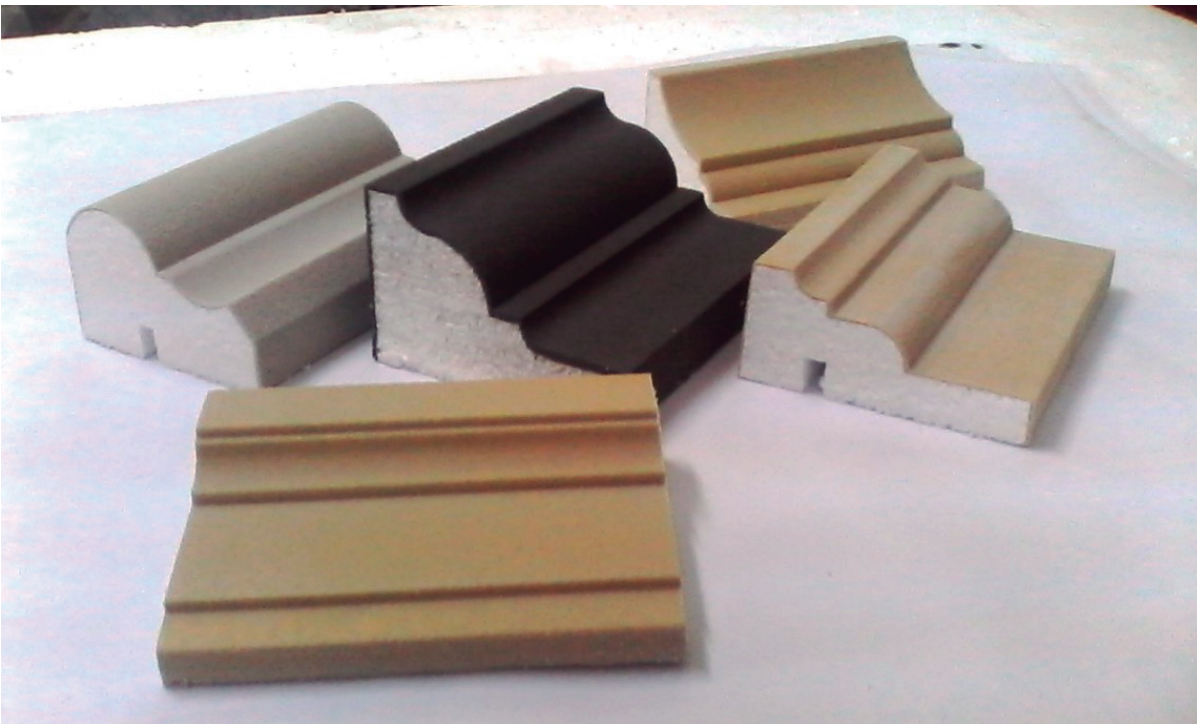

España

+34868128999
+34619199399
+34606852013

Estados Unidos

+1 407 413 9329

Panamá

+507 833 7662

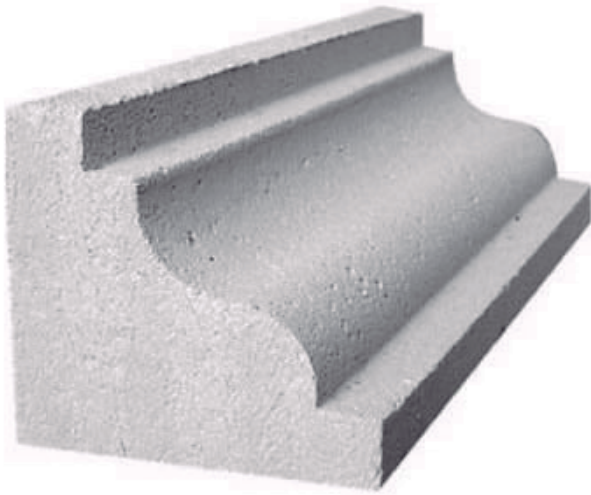
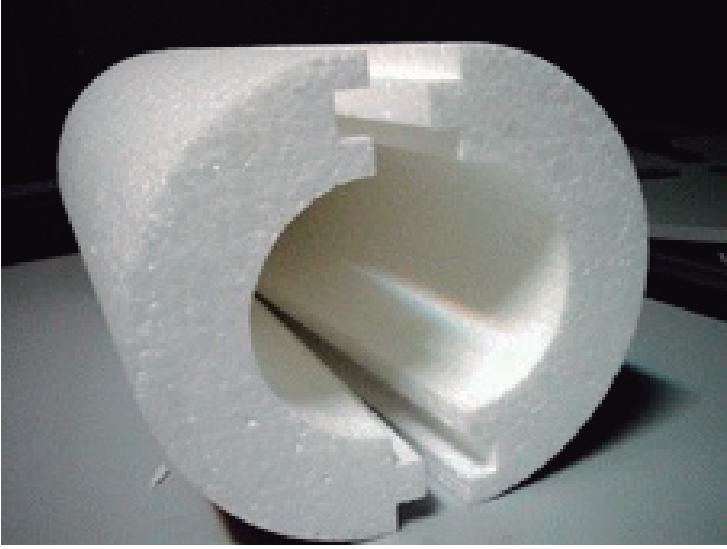

España

+34868128999
+34619199399
+34606852013

Estados Unidos

+1 407 413 9329

Panamá

+507 833 7662

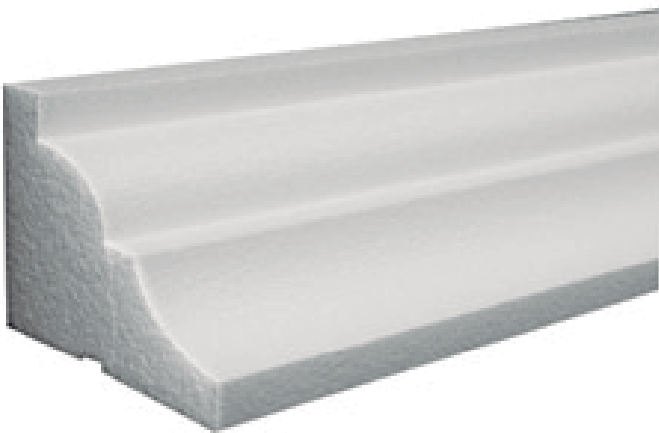
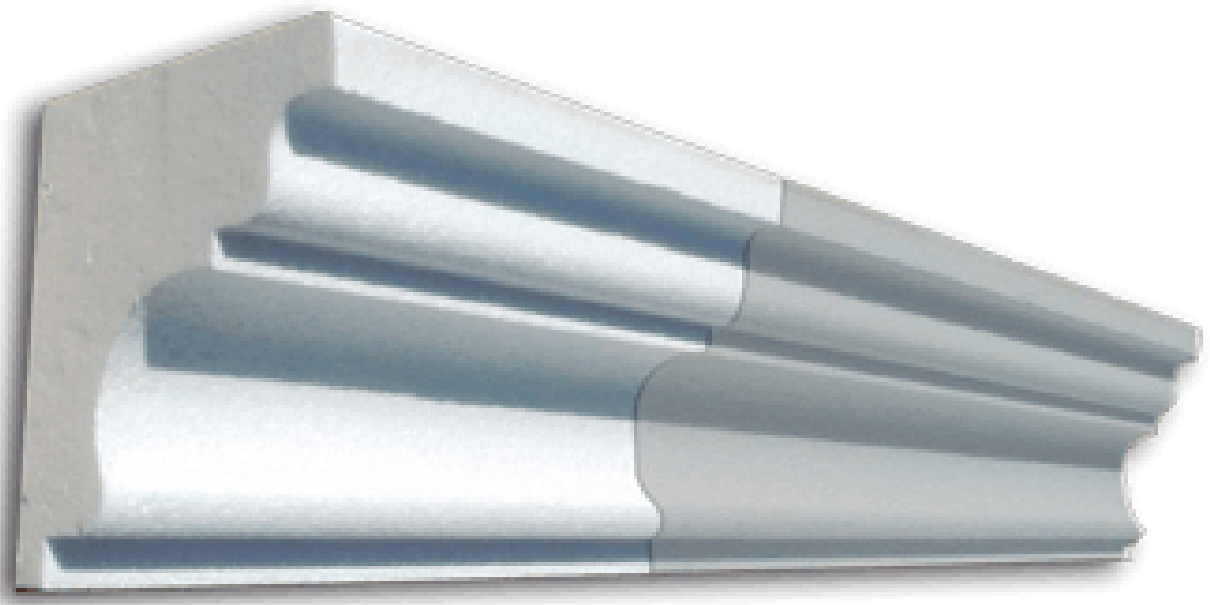

España

+34868128999
+34619199399
+34606852013

Estados Unidos

+1 407 413 9329

Panamá

+507 833 7662

INSTALLATION

quickmolding can be installed on any type of wall, using the suitable adhesive

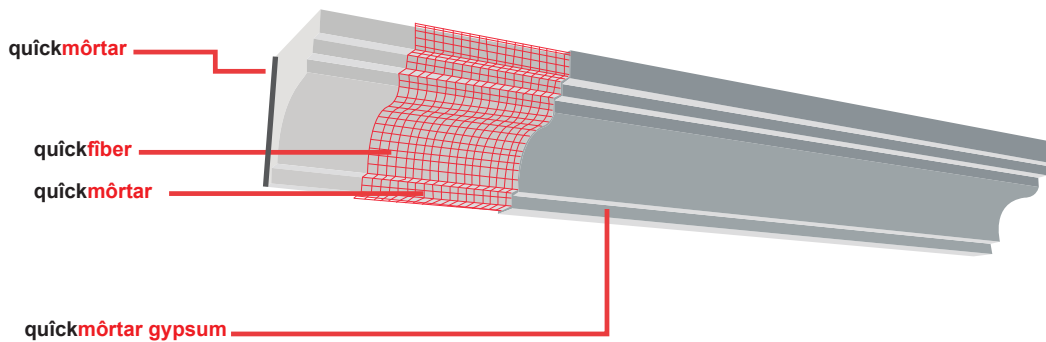

INSTRUCTIONS

- Check that the wall where the molding is placed is plumb
- Mark the level where the molding will be installed
- Prepare the adhesive quickmôrtar
- Place quickmôrtar on the wall and on the molding
- Install the molding
- Detail the molding
- Finish



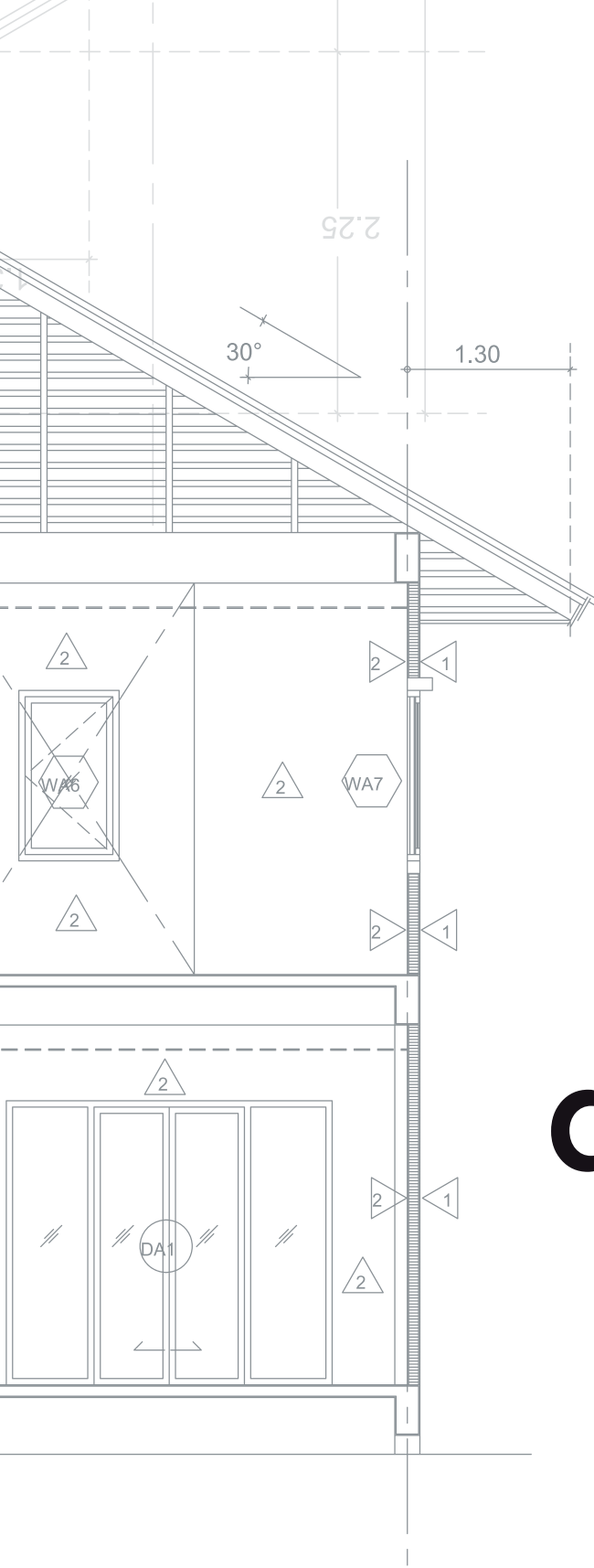

quïckplâck®

España

+34868128999

+34619199399

+34606852013

Panamá

+507 833 7662

Estados Unidos

+1 407 413 9329

quickplack@quickplack.com

www.quickplack.com